



275 USt



246 ft



282 ft



364 ft

Long, powerful and versatile!

LTM 1230-5.1

Mobile crane
Grue mobile

LIEBHERR

Mobile and crawler cranes



Technical data

Caractéristiques technique

Dimensions	
Encombrement	3
Mobile crane	
Grue mobile	4-5
Fuel saving and noise reduction	
Economie de carburant et réduction du bruit	6-7
Crane data	
Dates de la grue	8
Counterweight	
Contrepoids	9
On-road driving	
Déplacement sur route	10
Jobsite driving	
Déplacement sur chantier	10
Boom/jib combinations	
Configurations de flèche	11; 14
Variable boom system	
Systèmes de flèche variables	12-13
T	15-21
TK/TNZK	22-26
TVK/TVNZK	27-41
TS	42-49
TNZF	50-61
Equipment	
Equipement	62-63
Description of symbols	
Explication des symboles	64
Remarks	
Remarques	65

Dimensions

Encombrement

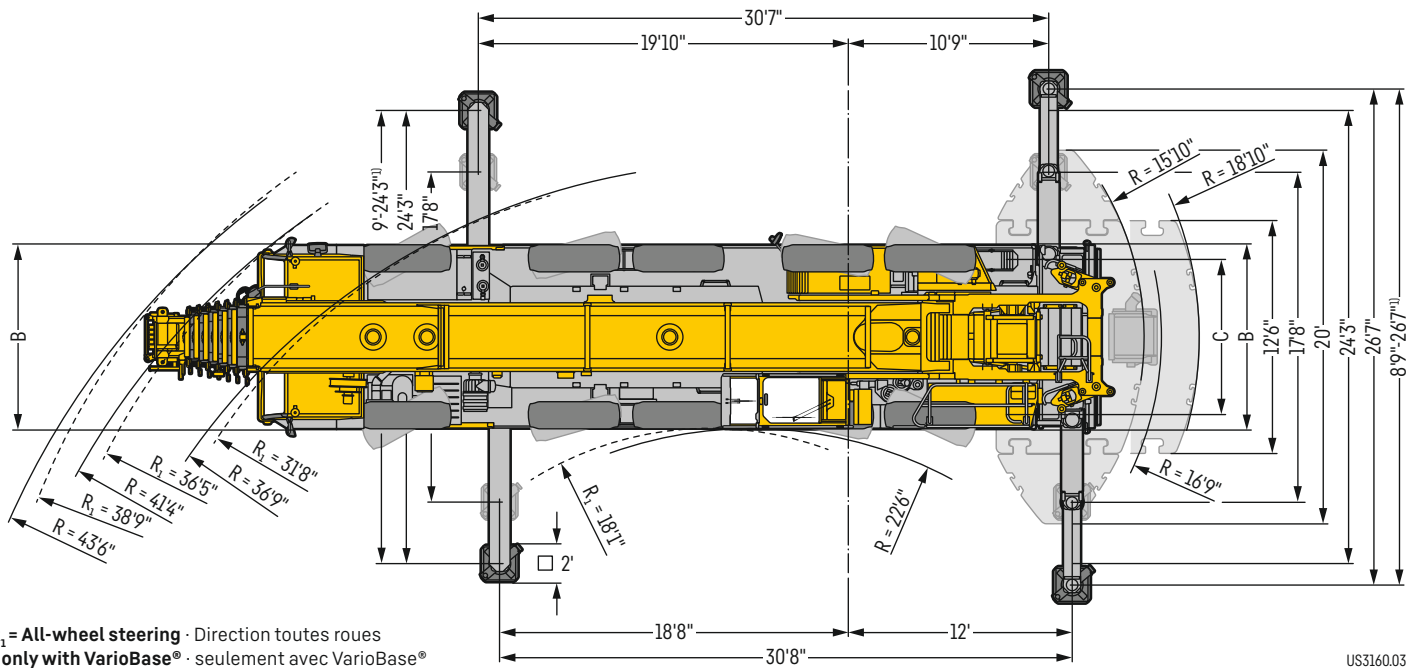
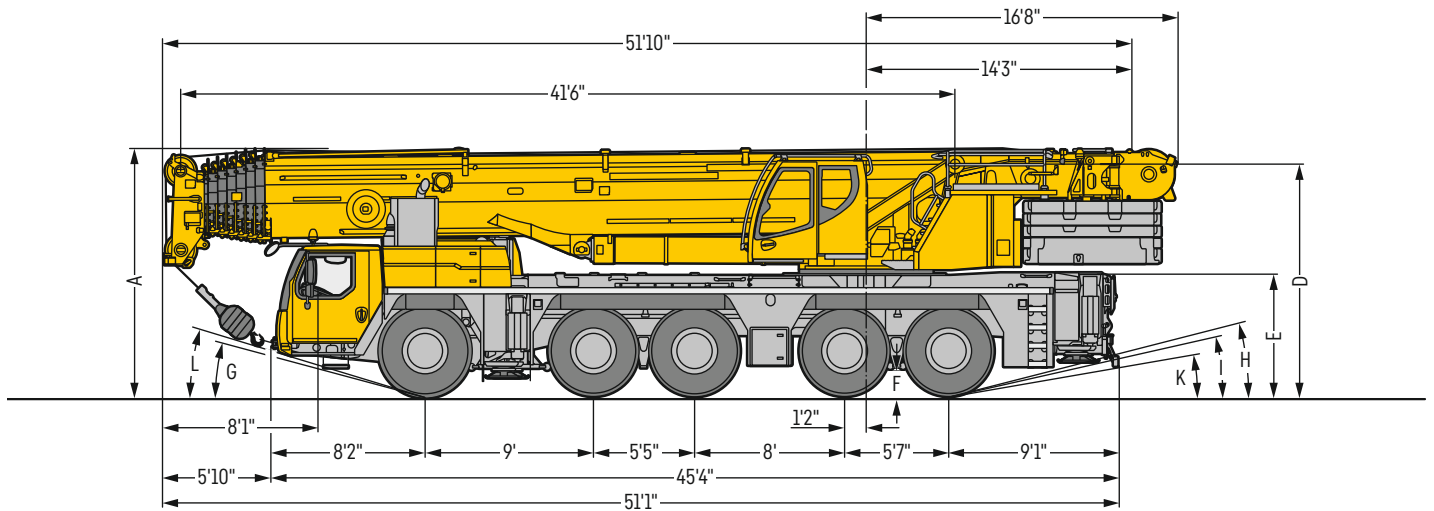

R_1 = All-wheel steering · Direction toutes roues
¹⁾ only with VarioBase® · seulement avec VarioBase®

US3160.03

Dimensions · Encombrement

	A	A	B	C	D	E	F	G	H	I	K	L
445/95 R 25 (16.00 R 25)	13'1"	12'9" 5"*	9'10"	8'4"	12'4"	6'5"	1'3"	15°	14°	13°	9°	16°
525/80 R 25 (20.5 R 25)	13'1"	12'9"	10'2"	8'5"	12'4"	6'5"	1'3"	15°	14°	13°	9°	16°

* lowered · abaissé

LTM 1230-5.1



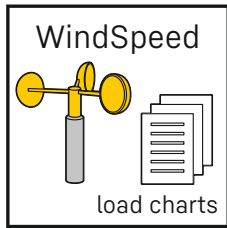

Increased flexibility and safety by using lifting capacity tables with different maximum wind speeds.

Une flexibilité et une sécurité accrues grâce aux tableaux de charge avec différentes vitesses de vent autorisées.

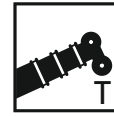

246 ft



38 ft – 66 ft

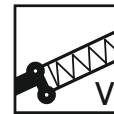

3 x 23 ft



26 ft – 141 ft



13 ft – 128 ft

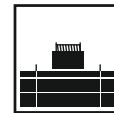

158,700 lb



400 KW / 544 h.p.

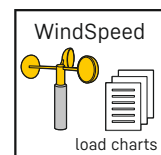
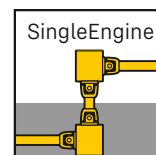
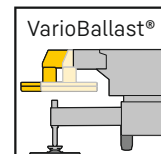
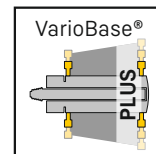

Fuel saving and noise reduction

Economie de carburant et réduction du bruit

ECOdrive
TRAXON

Driving strategy in the carrier with ECO- or Power-mode to reduce noise and fuel

L'adaptation du mode de déplacement avec le mode ECO ou le mode Puissance permet de réduire le niveau sonore et la consommation de carburant

ZF-TraXon

**Automated shift gearbox,
12 forward gears, 2 reverse gears**

Boîte de vitesses automatisée,
12 vitesses avant, 2 vitesses arrière

Innovative One-Engine-Concept

Concept innovant à moteur unique

**Drive from chassis engine via a mechanical shaft
with special high efficiency factor**

**Increased effectiveness and reduced maintenance
expenditure**

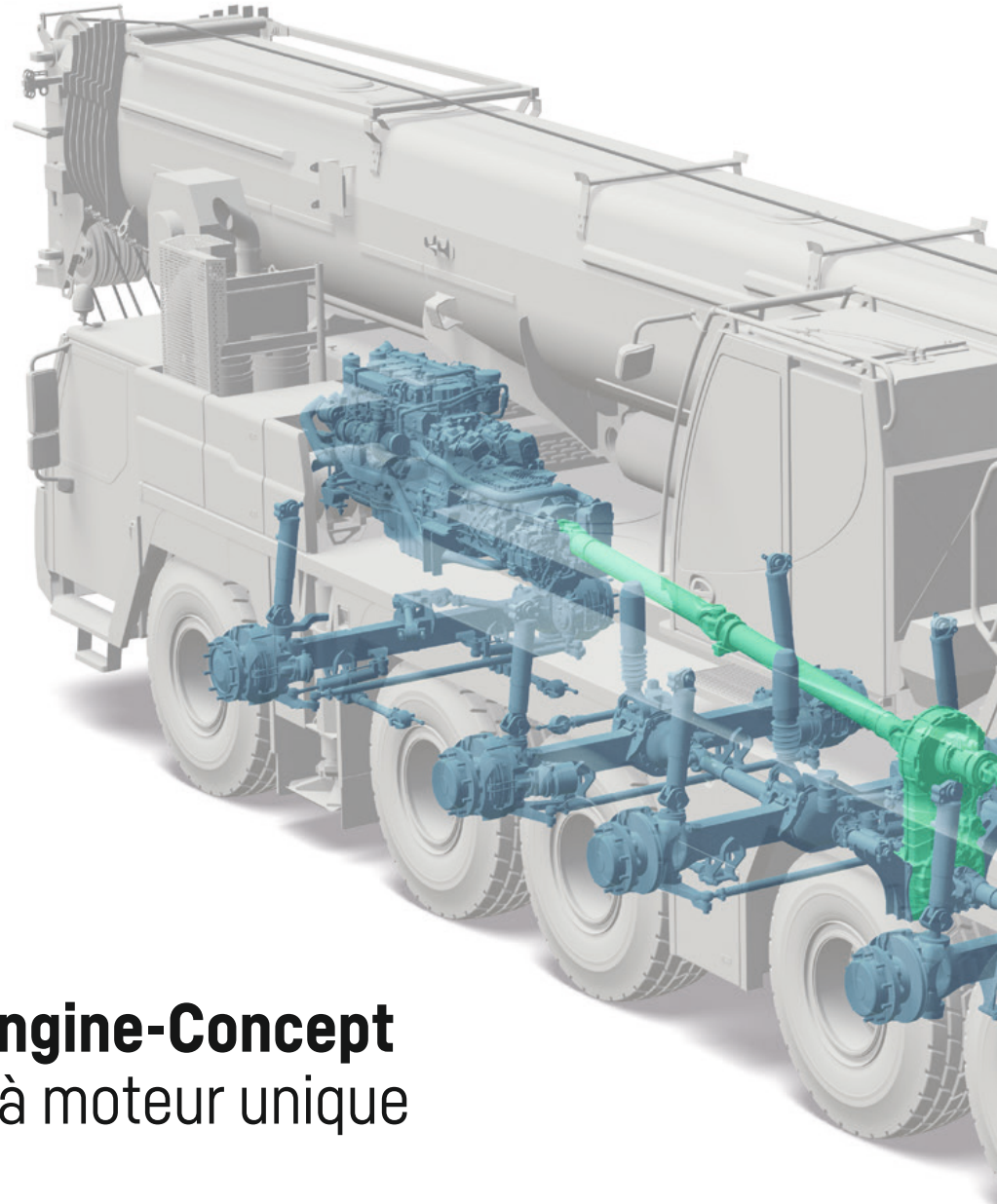

Entraînement du moteur du châssis par le biais d'un
arbre mécanique particulièrement performant

Rentabilité accrue et entretien nettement réduit



ECOnode





Reduced fuel consumption due to automatic disengaging of the complete pump drive at engine idling with automatic speed adjustment

Réduction de la consommation de carburant par désengagement automatique de l'entraînement complet de la pompe en mode ralenti avec adaptation automatique du régime









Crane data

Dates de la grue

Hook block - Moufles à crochet



			
332,900 lb	9	16	4,200 lb
314,400 lb	7	14	3,750 lb
237,450 lb	5	11	3,530 lb
155,650 lb	3	7	3,200 lb
68,800 lb	1	3	1,850 lb
23,150 lb	-	1	1,100 lb

Crane carrier - Châssis porteur









	 mph min.	 mph max.	 %		
445/95 R 25 (16.00 R 25)	0.3	53	56,5 %		12 / R2
525/80 R 25 (20.5 R 25)	0.3	53	56,5 %		4 / R2

Theoretical gradeability - Aptitude théorique en pente

Max. supporting forces - Forces d'appui max.

		
F _{max}	173,000 lb	250,000 lb

Crane superstructure - Partie tournante

			
 0 - 440 ft/min single line · au brin simple	23 mm	984 ft	23,605 lb
 0 - 440 ft/min single line · au brin simple	23 mm	920 ft	23,605 lb
 0 - 1.2 rpm			
 approx. 55 seconds to reach 83° boom angle env. 55 s jusqu'à 83°			
 approx. 680 seconds for boom extension from 41 ft - 246 ft env. 680 s pour passer de 41 ft - 246 ft			

VarioBallast

Counterweight radius

Rayon de contrepoids

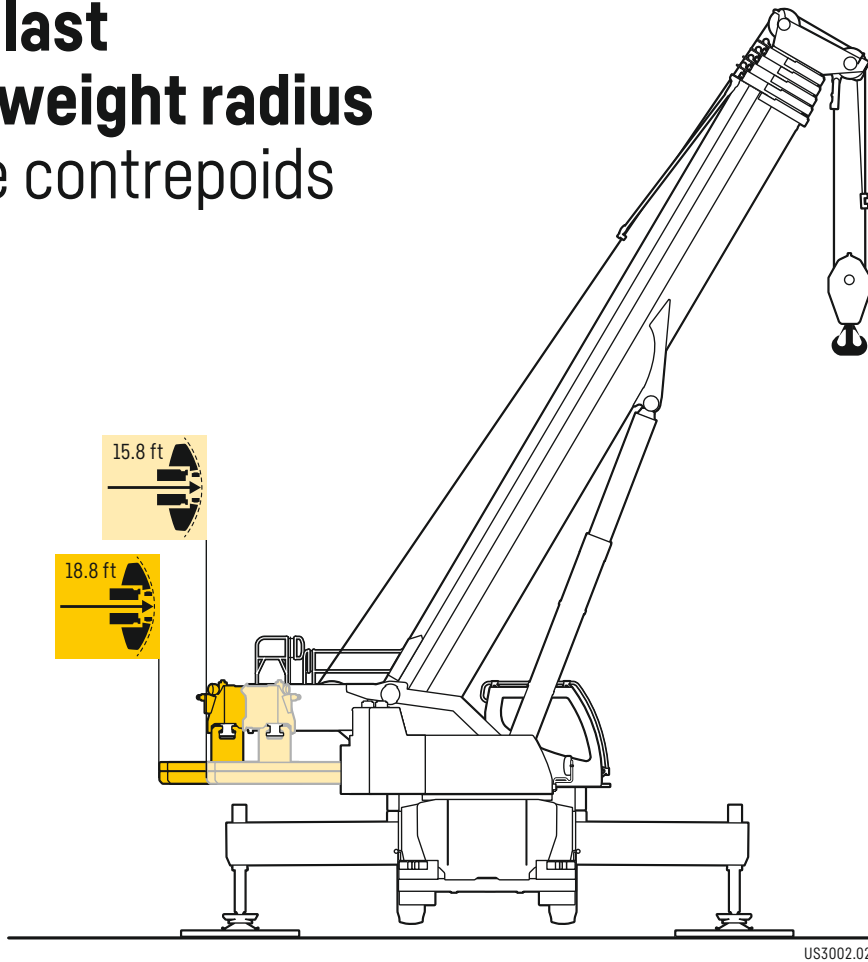

Counterweight

Contrepoids

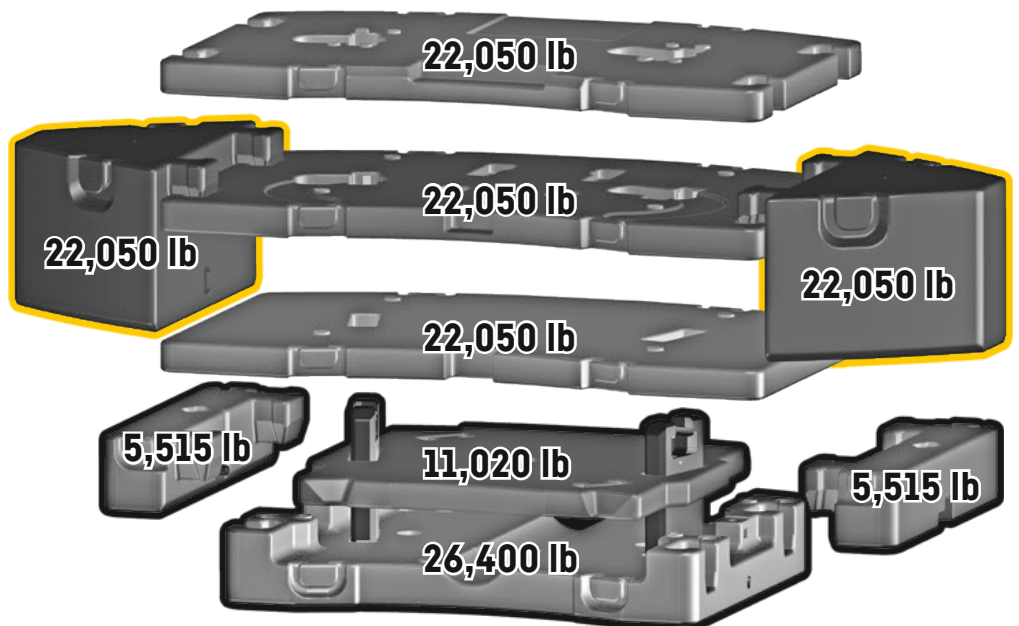

Technically transportable
Transport techniquement simplifié

Additional counterweight
Contrepoids additionnel

On-road driving

Déplacement sur route

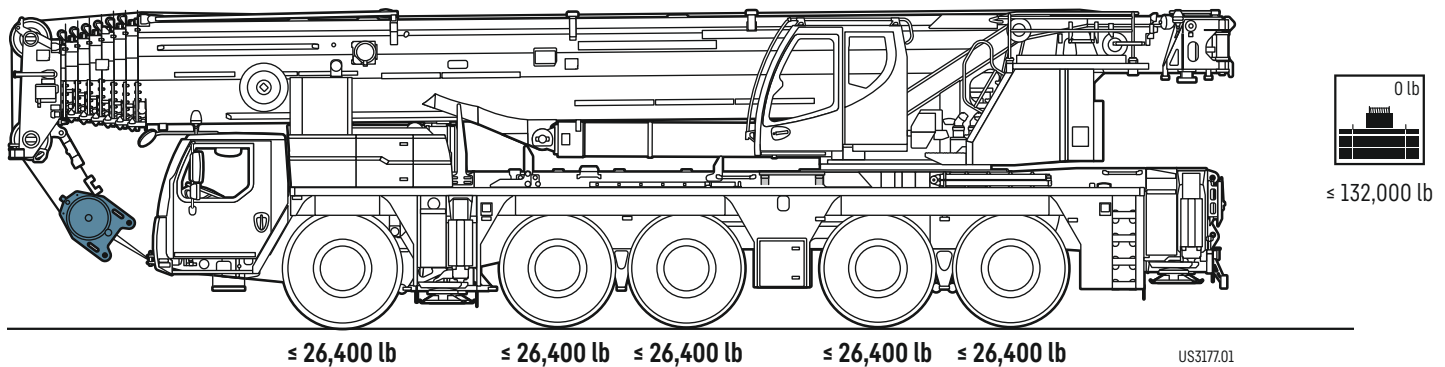

Jobsite driving

Déplacement sur chantier

optional - en option

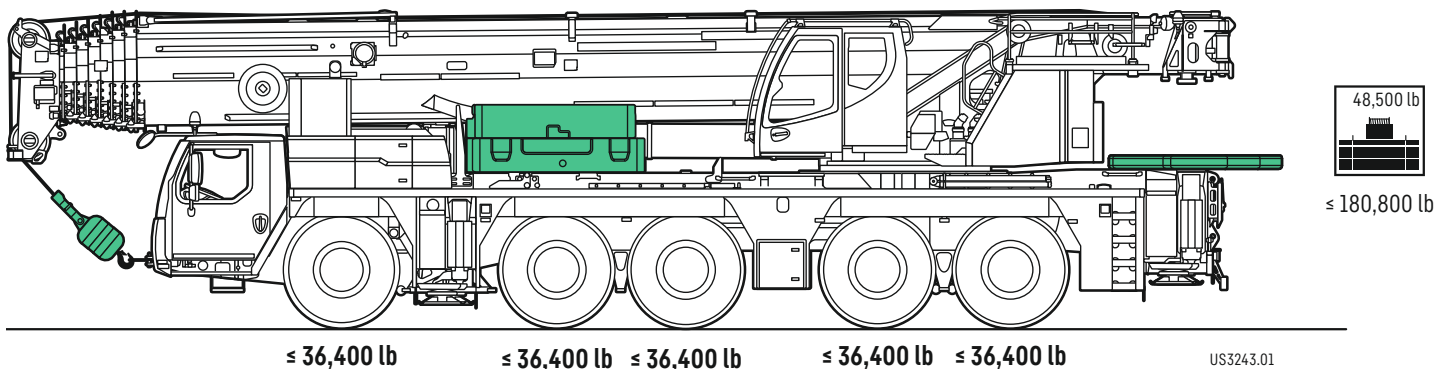
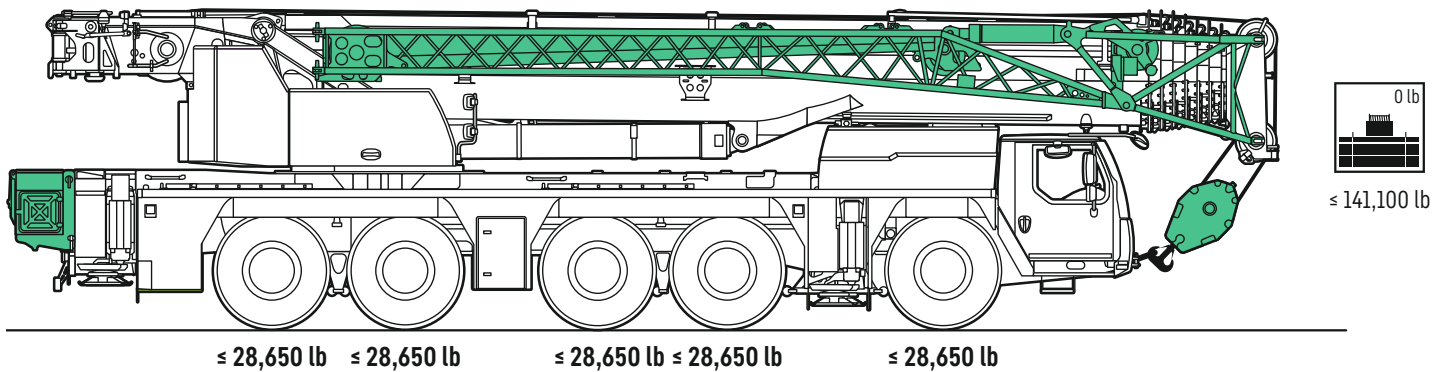

Boom/jib combinations – Powerful jib

Configurations de flèche – Flechette particulièrement puissante

TS

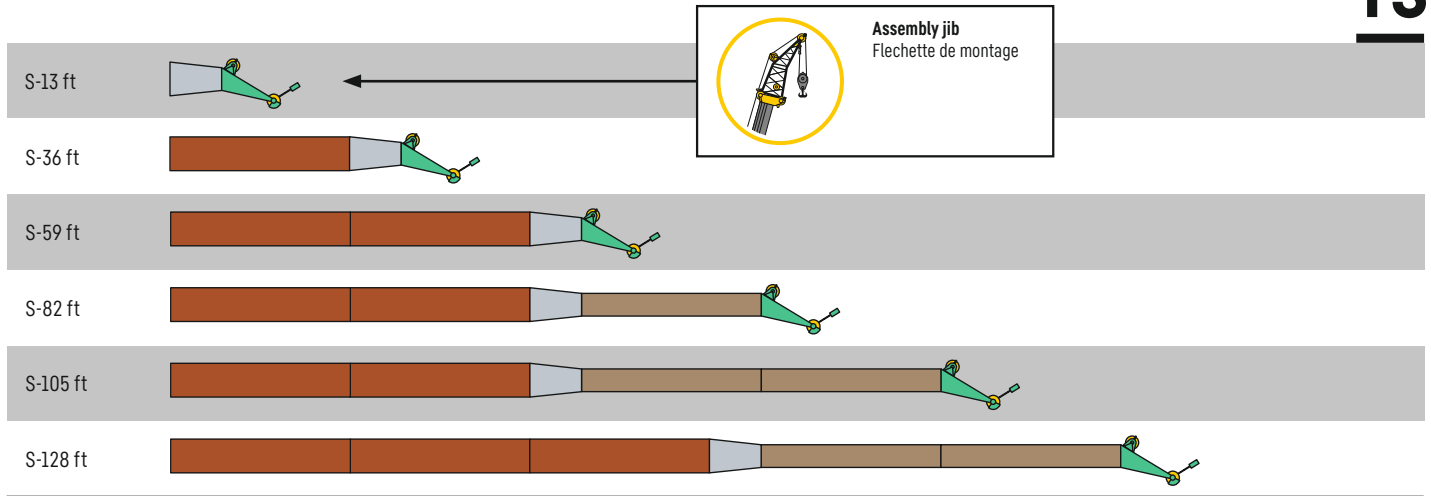



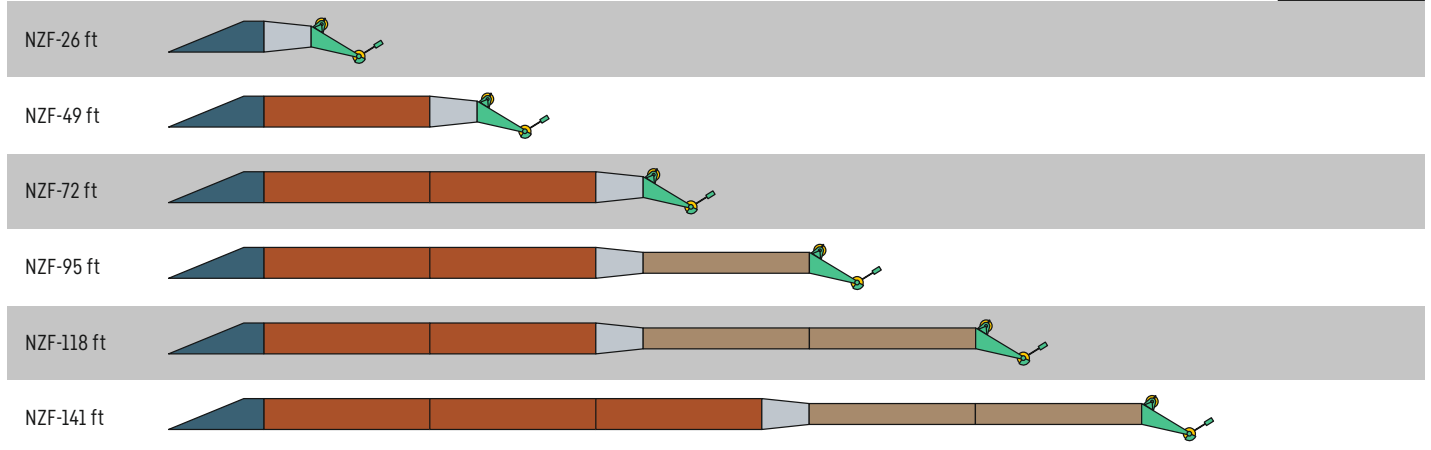

Boom/jib combinations – Hydraulically adjustable fixed lattice jib

Configurations de flèche – Fléchette treillis fixe réglable hydrauliquement

TNZF



-  13 ft F-shaped base section · Élément de base F
-  23 ft Telescopic boom extension · Rallonge flèche télescopique
-  6.5 ft Reduction section · Élément réducteur
-  23 ft Swing away jib extension · Rallonge flechette pliante
-  6.5 ft F head section · Élément de tête F

US3191.01

Variable boom systems

Systèmes de flèche variables

TVK TVNZK

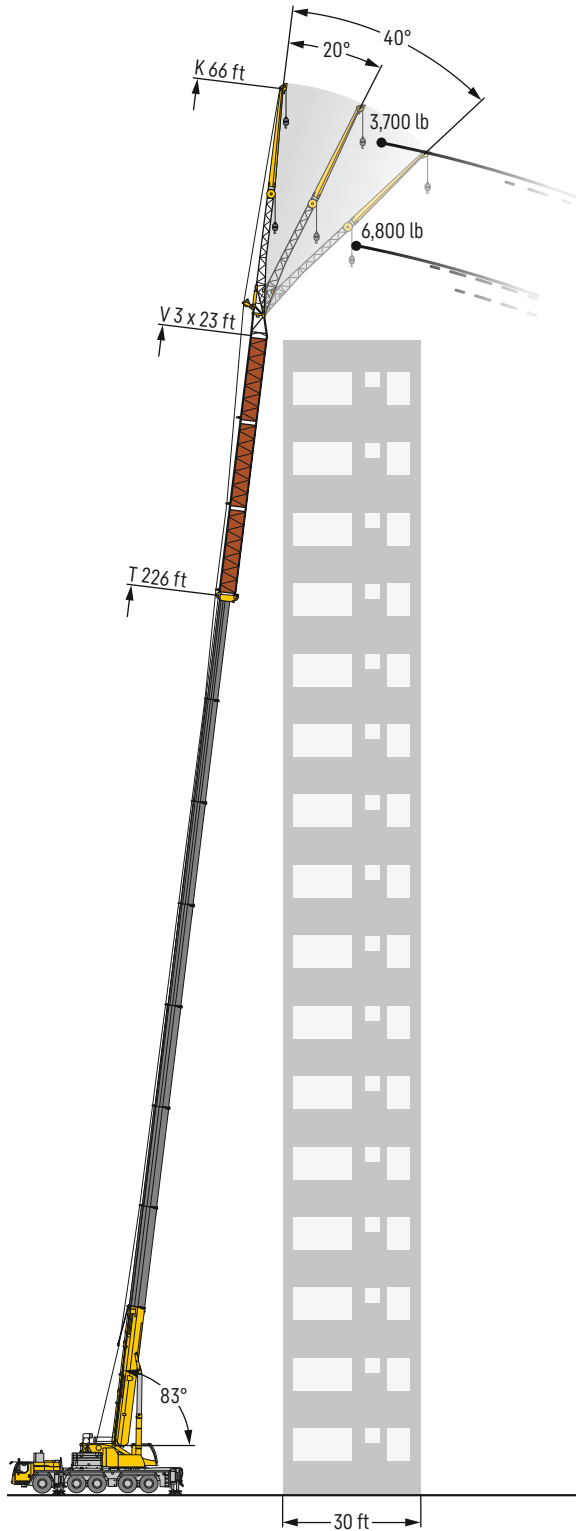

TNZF

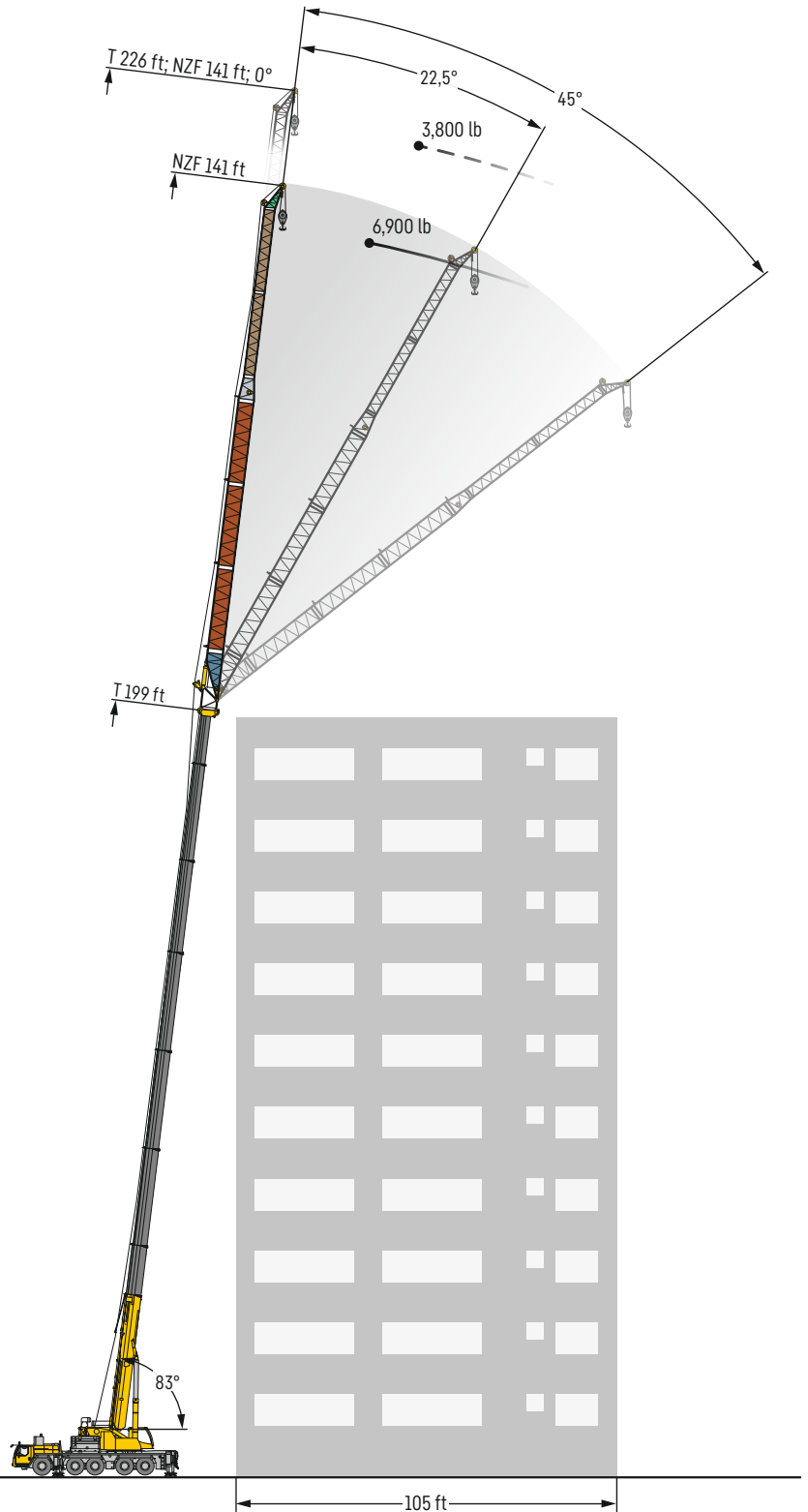

TS

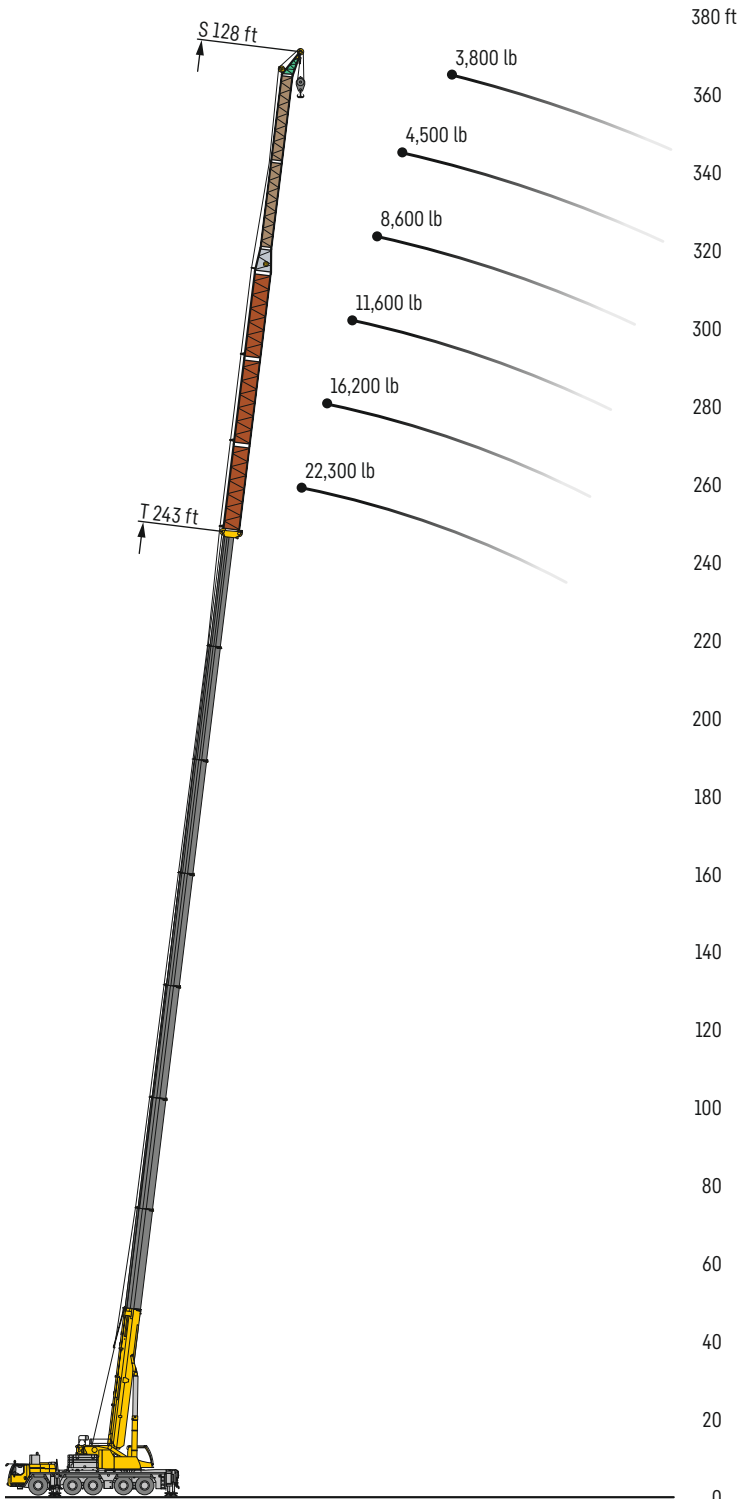

US3197.02

TVK TVNZK

K 38 ft - 66 ft
0°; 20°; 40°

NZK 38 ft - 66 ft
0° - 40°

V 3 x 23 ft

66 ft double swing away jib, can technically be carried on crane

Double fléchette pliante de 66 ft avec maintien à demeure sur la grue

TNZF TS

NZF 26 ft - 141 ft
0° - 45°

S 13 ft - 128 ft
0°

Fixed jib contains strong jib

Fléchette fixe avec fléchette robuste

TS

S 13 ft - 128 ft
0°

Strong system for steep working positions

Système puissant pour les positions de travail les plus raides



23 ft Telescopic boom extension - Rallonge flèche télescopique



23 ft Swing away jib extension - Rallonge fléchette pliante

Boom/jib combinations

Configurations de flèche

T Telescopic boom - Flèche télescopique

K/NZK Mechanically/hydraulically adjustable folding jib - Pointe pliante réglable mécaniquement/hydrauliquement

V Telescopic boom extension - Rallonge de flèche télescopique

S Strong jib - Fléchette particulièrement puissante

NZF Hydraulically adjustable fixed lattice jib - Fléchette treillis fixe réglable hydrauliquement



S3190.02

Lifting heights

Hauteurs de levage

T

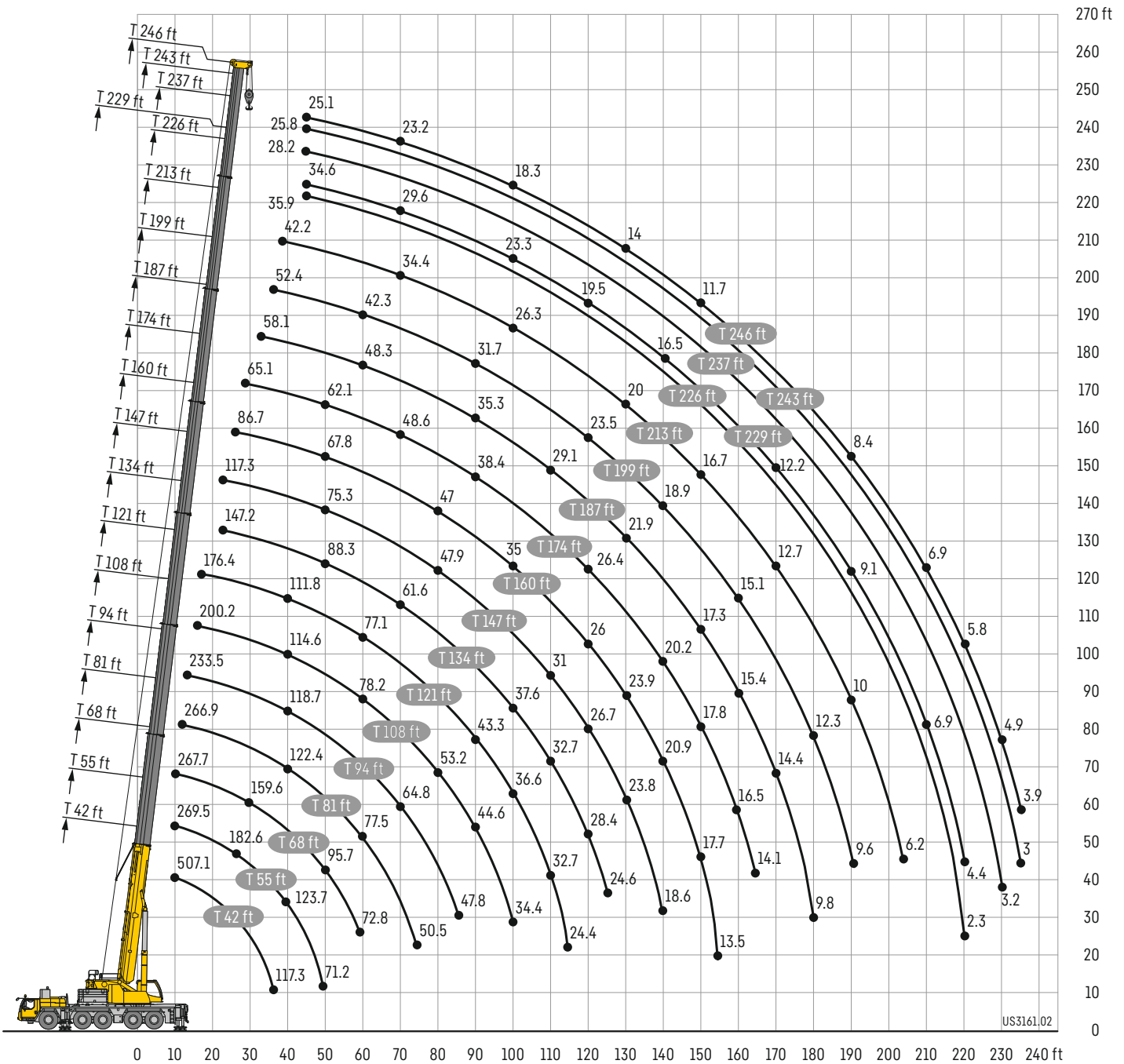

Lifting capacities

Forces de levage

T

42 - 246 ft
360°
158,700 lb
15.8 ft
18.8 ft
85%

	42ft		55ft	68ft	81ft	94ft	108ft	121ft	134ft	147ft	
	*										
10	507.1	295.4	269.5	267.7							10
11	325.7	295.4	270.7	268.6	266.9						11
12	316.2	295.4	272.1	269.5	267.6						12
13	306.6	289.7	273.6	270.5	268.4	233.5					13
14	297.6	278.3	273.3	270	264.1	234					14
15	287.7	267.5	265.8	265.1	254.7	234.1	200.2				15
16	275.3	257.3	255.5	254.2	239.9	228.8	200.7				16
17	263.8	247.3	247	244.9	231.4	219.9	201.2				17
18	253.3	238.1	237.8	234.6	224.4	211.8	201.8	176.4			18
19	243.5	229.4	229.3	225.1	216.4	204.1	195.8	176.5			19
20	234.4	221.2	221.8	216.4	208.6	199.1	189.5	176.4			20
22	217.8	206.3	207.8	204.5	197.6	188.1	180.6	170.7	147.2		22
24	203.1	193.2	194.7	191.2	185.3	179.1	170.2	161.6	145.9	117.3	24
26	189.6	181.1	182.6	179.4	176	168.8	160.9	152.8	144.3	114.6	26
28	176.9	170.1	172.2	168.9	165.9	159.5	152.1	145	140.3	111.2	28
30	164.6	160.3	162.5	159.6	156.6	151.2	144.3	139.8	133.6	107.1	30
32	151.9	151.4	153.5	151.1	148.3	143.8	137.1	133.6	127.5	103.2	32
34	137.6	137.6	145.3	143.5	141	136.8	130.6	127.4	121.6	99.5	34
36	117.3	117.3	137.5	136.5	134.3	130.3	124.7	121.8	116.2	95.8	36
38			130.5	130	128.1	124.2	119.5	116.6	111.2	92.4	38
40			123.7	123.4	122.4	118.7	114.6	111.8	106.7	89.1	40
45			106.3	108.6	109.8	106.7	105.1	101.5	96.7	81.7	45
50			71.2	95.7	97.3	96.4	95.8	92.8	88.3	75.3	50
55				86	86.6	86	87.1	84.8	81.2	69.5	55
60				72.8	77.5	76.9	78.2	77.1	74.4	64.3	60
65					69.9	71	70.5	69.5	67.6	59.6	65
70					63.2	64.8	64	62.9	61.6	55.5	70
75					50.5	59.3	58.4	57.3	55.8	51.5	75
80						54.2	53.2	52	50.4	47.9	80
85						47.8	48.6	47.3	45.8	45.1	85
90							44.6	43.3	41.7	42.9	90
95							41.1	39.7	39.1	39.6	95
100							34.4	36.6	37.6	36.4	100
105								33.9	35.2	33.6	105
110								32.7	32.7	31	110
115								24.4	30.4	28.7	115
120									28.4	26.7	120
125									24.6	24.8	125
130										23.8	130
135										22.6	135
140										18.6	140

* over rear - en arrière

t_270_001_10001_00_000 / t_270_001_21501_00_000 / t_270_001_11501_00_000

Lifting capacities

Forces de levage

T

42 - 246 ft

360°

158,700 lb

15.8 ft

18.8 ft

85%

	160 ft	174 ft	187 ft	199 ft	213 ft	226 ft	229 ft	237 ft	243 ft	246 ft	
26	86.7										26
28	93.9	65.1									28
30	92.2	76.6									30
32	89.3	75.6	58.1								32
34	86.5	74.1	63.2								34
36	83.8	72.7	62.4	52.4							36
38	81.2	71.2	61.3	52.1	42.2						38
40	78.7	69.8	60	51.5	43.4						40
45	73	66.2	56.7	49.2	42.6	35.9	34.6	28.2	25.8	25.1	45
50	67.8	62.1	53.7	46.8	41.1	35	33.8	27.6	26.1	25.5	50
55	63.3	58.2	50.9	44.5	39.3	33.8	32.7	26.8	25.4	24.9	55
60	59.1	54.8	48.3	42.3	37.6	32.7	31.6	26	24.7	24.2	60
65	56.1	51.6	45.9	40.3	36	31.6	30.6	25.2	23.9	23.5	65
70	53.2	48.6	43.6	38.5	34.4	30.5	29.6	24.4	23.2	22.8	70
75	50.2	45.9	41.4	36.7	33	29.4	28.5	23.6	22.4	22	75
80	47	43.3	39.4	35	31.6	28.2	27.5	22.7	21.6	21.3	80
85	44	40.9	37.3	33.4	30.3	27.1	26.4	22	20.8	20.4	85
90	41.3	38.4	35.3	31.7	28.9	26	25.4	21.2	19.9	19.7	90
95	38.2	36.2	33.4	30.2	27.6	24.9	24.4	20.4	19.1	18.9	95
100	35	34	31.8	28.8	26.3	23.8	23.3	19.7	18.3	18.1	100
105	32.8	31.5	30.5	27.4	25.1	22.7	22.3	19	17.5	17.4	105
110	30.3	29.2	29.1	26.1	24	21.7	21.4	18.3	16.7	16.6	110
115	28	28	27.5	24.8	22.9	20.8	20.4	17.7	16	15.9	115
120	26	26.4	25.5	23.5	21.8	19.9	19.5	17.1	15.3	15.2	120
125	25.1	24.9	23.6	22.4	20.9	19	18.7	16.5	14.7	14.5	125
130	23.9	23.2	21.9	21.3	20	18.2	17.9	16	14	13.9	130
135	22.3	21.6	20.3	20.2	19.2	17.5	17.2	15.4	13.4	13.2	135
140	20.9	20.2	18.9	18.9	18.4	16.7	16.5	14.9	12.8	12.5	140
145	19.6	18.8	18.1	17.7	17.4	16	15.8	14.5	12.3	11.9	145
150	17.7	17.8	17.3	17.1	16.7	15.4	15.2	14	11.7	11.2	150
155	13.5	17.3	16.3	16.2	15.8	14.8	14.6	13.5	11.2	10.6	155
160		16.5	15.4	15.1	14.8	14.1	14	13	10.7	10.1	160
165		14.1	14.9	14.4	13.7	13.1	13.2	12.5	10.2	9.6	165
170			14.4	13.9	12.7	12.1	12.2	12	9.8	9.1	170
175			12.9	13.1	12	11.2	11.3	11.4	9.4	8.7	175
180			9.8	12.3	11.4	10.3	10.4	10.6	9.1	8.3	180
185				11.5	10.7	9.6	9.7	9.8	8.7	7.9	185
190				9.6	10	9	9.1	9.2	8.4	7.6	190
195					9.4	8.4	8.5	8.6	8.1	7.2	195
200					8.6	7.9	8	8.1	7.8	6.9	200
205						6.2	7.3	7.4	7.6	6.6	205
210							6.7	6.9	7	6.2	210
215							5.6	6.3	6.5	6.3	215
220							2.3	4.4	6	5.8	220
225									5.4	5.3	225
230									3.2	4.9	230
235										3	235

t_270_001_21501_00_000 / t_270_001_11501_00_000

Lifting capacities

Forces de levage

T

42 - 246 ft

103,600 lb

15.8 ft

18.8 ft

85%

	42 ft	55 ft	68 ft	81 ft	94 ft	108 ft	121 ft	134 ft	147 ft	
10	295.4	269.5	267.7							10
11	295.4	270.7	268.6	266.9						11
12	295.4	272.1	269.5	267.6						12
13	285.9	273.6	270.5	268.4	233.5					13
14	273.7	270.2	267.2	263.1	234					14
15	262.2	260.4	260.2	253	234.1	200.2				15
16	251.5	250.4	249.9	239.7	228.8	200.7				16
17	241.8	241.5	241	231.4	219.9	201.2				17
18	232.4	232.2	231.7	224.4	211.8	201.8	176.4			18
19	223.4	223.3	222.6	216.4	204.1	195.8	176.5			19
20	214.8	215.5	214.2	208.6	199.1	189.5	176.4			20
22	199.4	201	201.2	197.6	188.1	180.6	170.7	147.2		22
24	185.4	187	187.4	185.3	179.1	170.2	161.6	145.9	117.3	24
26	172.3	174.8	174.5	174.9	168.8	160.9	152.8	144.3	114.6	26
28	159.9	162.5	162.4	163.3	158.7	152.1	145	139.9	111.2	28
30	148.4	151.3	151	152.2	147.9	142	137.8	131.5	107.1	30
32	137.5	140.4	140.3	141.8	137.9	133.2	128.3	121.6	103.2	32
34	127.5	130.5	131.2	132.1	127.7	124.9	119.1	113	99.5	34
36	117.2	121.5	122.9	123.2	118.8	116.3	110.9	105.1	95.8	36
38		113.5	114.9	115.1	111.3	108.8	103.5	98	91.9	38
40		106.3	107.8	107.8	105.9	101.7	96.8	91.8	87	40
45		88.6	90.2	90.5	91.1	87.2	83.1	78.6	75.9	45
50		71.2	75.9	78.3	78.2	75.8	72.3	69	66	50
55			66.5	67.3	67.1	66.2	63.5	60.7	60.4	55
60			58	58.6	58.4	57.6	56.2	55.8	54.4	60
65				51.7	51.5	50.5	49.6	51	48.8	65
70				46	45.7	44.8	46.5	45.3	44.6	70
75				41.4	40.9	40.9	41.7	40.5	40.1	75
80					36.9	38.4	37.6	36.4	35.9	80
85					33.5	34.9	34	33	33.3	85
90						31.9	31	30.8	30.6	90
95						29.2	28.3	28.3	27.8	95
100						26.9	25.9	26.6	25.4	100
105							23.8	24.5	23.7	105
110							22.8	22.6	22.4	110
115							21.9	20.9	20.8	115
120								19.4	19.5	120
125								18	18.1	125
130									16.8	130
135									15.6	135
140									14.5	140

t_270_001_11505_00_000 / t_270_001_21505_00_000

Lifting capacities

Forces de levage

T

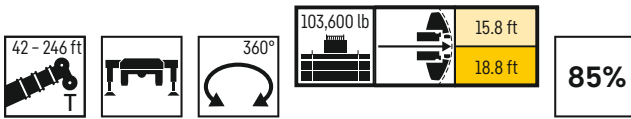

	160 ft	174 ft	187 ft	188 ft	199 ft	213 ft	217 ft	226 ft	229 ft	230 ft	237 ft	243 ft	246 ft	
26	86.7													26
28	93.9	65.1												28
30	92.2	76.6												30
32	89.3	75.6	58.1											32
34	86.5	74.1	63.2	36.8										34
36	83.8	72.7	62.4	36.4	52.4									36
38	81.2	71.2	61.3	35.8	52.1	42.2								38
40	78.7	69.8	60	35.2	51.5	43.4	30.8							40
45	71.7	66.2	56.7	33.6	49.2	42.6	30	35.9	34.6	28.1	28.2	25.8	25.1	45
50	64.6	61.9	53.7	32	46.8	41.1	29	35	33.8	27.4	27.6	26.1	25.5	50
55	58.3	55.1	50.9	30.5	44.5	39.3	28	33.8	32.7	26.7	26.8	25.4	24.9	55
60	51.7	48.9	47.8	29	42.3	37.6	27	32.7	31.6	25.9	26	24.7	24.2	60
65	46.3	44.9	42.8	27.7	40.3	36	26.1	31.6	30.6	25	25.2	23.9	23.5	65
70	42.5	41	39.3	26.3	37.2	34.4	25.1	30.5	29.6	24.1	24.4	23.2	22.8	70
75	38.7	37.8	35.7	25	34.2	32.5	24	29.4	28.5	23.2	23.6	22.4	22	75
80	36	34.3	33	23.6	32	30.3	22.9	28.2	27.5	22.3	22.7	21.6	21.3	80
85	32.6	31.2	30.3	22.2	29.2	27.6	21.7	26.6	26.4	21.4	22	20.8	20.4	85
90	29.5	29.5	28.2	21	26.8	26.1	20.6	24.5	24.4	20.4	21.2	19.9	19.7	90
95	26.8	27.3	26.1	19.8	25.3	24.3	19.6	22.5	22.5	19.5	20.4	19.1	18.9	95
100	25.3	25	24.1	18.7	23.6	22.3	18.6	20.6	20.6	18.6	19.5	18.3	18.1	100
105	23.6	22.7	22.6	17.6	22	20.5	17.7	18.8	18.9	17.7	18.5	17.5	17.3	105
110	21.8	21.5	21.1	16.7	20	18.9	16.8	17.2	17.3	16.9	17.1	16.4	16.2	110
115	20	19.7	19.3	15.7	18.3	17.2	15.9	15.8	15.8	16.1	15.7	15.3	15	115
120	18.4	18.3	17.7	14.9	16.6	15.6	15.1	14.4	14.5	15.4	14.4	14	13.7	120
125	17.6	16.8	16.2	14.1	15.2	14.2	14.4	12.9	13.1	14.1	13.2	12.8	12.5	125
130	16.4	15.4	14.9	13.3	13.8	12.8	13.5	11.6	11.8	12.8	11.9	11.7	11.4	130
135	15.1	14.2	13.6	12.6	12.6	11.6	12.5	10.4	10.6	11.6	10.7	10.4	10.2	135
140	14	13.1	12.5	11.9	11.5	10.5	11.4	9.4	9.5	10.4	9.7	9.5	9.3	140
145	13	12	11.4	11.3	10.4	9.6	10.3	8.6	8.7	9.6	8.8	8.6	8.4	145
150	12.1	11.1	10.5	10.7	9.6	8.8	9.5	7.8	7.9	8.8	8	7.9	7.7	150
155	11.4	10.2	9.7	10.2	8.8	8	8.8	7.1	7.2	8	7.3	7.1	7	155
160		9.6	9	9.6	8.2	7.4	8.1	6.4	6.5	7.4	6.7	6.5	6.3	160
165		9	8.4	9	7.6	6.8	7.5	5.7	5.9	6.8	6	5.9	5.7	165
170			7.8	8.4	7	6.1	6.9	5	5.2	6.2	5.4	5.2	5	170
175			7.3	7.9	6.4	5.5	6.3	4.4	4.5	5.6	4.7	4.6	4.3	175
180			6.8	7.4	5.8	4.9	5.8	3.8	3.9	5	4.1	3.9	3.7	180
185					5.2	4.3	5.2	3.2	3.3	4.4	3.5	3.4	3.1	185
190					4.7	3.7	4.6	2.6	2.8	3.8	3	2.8	2.6	190
195						3.3	4.1		2.3	3.3	2.5	2.3		195
200						2.8	3.7			2.8				200
205						2.4	3.2			2.4				205
210							2.8							210

t_270_001_11505_00_000 / t_270_001_21505_00_000

Lifting capacities

Forces de levage

T

42 - 246 ft

360°

48,500 lb

15.8 ft

18.8 ft

85%

	42 ft	55 ft	68 ft	81 ft	94 ft	108 ft	121 ft	130 ft	134 ft	147 ft	159 ft	
10	295.4	269.5	267.7									10
11	295.4	270.7	268.6	266.9								11
12	291.2	272.1	269.5	267.6								12
13	278.5	271.8	268.2	265.3	233.5							13
14	265.6	263.6	261.9	254.5	234							14
15	253.5	251.6	250.4	243.2	233.3	200.2						15
16	242.3	242.1	240.6	232.6	218.6	200.7						16
17	231.4	231.2	229.8	218.6	200.2	188.1						17
18	220.9	221.6	218.8	202	190.7	178.4	164.9					18
19	210.5	211.3	204.9	191.4	180.2	169.5	158.7					19
20	200.1	201.5	192.2	178.3	169.2	160	148					20
22	179.6	179.5	168.7	157.6	150.4	139.9	130.2	58.3	120.4			22
24	160.7	155.7	147.4	141.2	132.5	123.9	115.6	56	108.4	101.2		24
26	141.7	136	129.7	125.2	118.2	110.9	103.7	53.9	97.4	91.4		26
28	124.2	120.3	117.8	112.6	106.3	100	93.7	51.8	88.1	85.8	45.1	28
30	107.4	109.1	106	101.5	96.2	90.8	86.7	49.9	83.9	80	44.2	30
32	93.9	98.4	96.1	92.3	88	82.9	81	47.9	77.5	73.7	43.2	32
34	83.1	88.7	87.8	84.6	80.7	77	75.7	46.1	71.5	68.1	42.2	34
36	74.2	79.5	80.6	77.9	74.5	72.5	70.1	44.3	67.3	64.1	41.1	36
38		71.8	74.3	72	68.8	68.3	65.1	42.6	62.8	59.7	40.1	38
40		65.3	68	66.8	63.9	64.1	60.9	41	58.7	56.3	39	40
45		52.5	55.2	56	56.2	54.5	52	37.4	51	49.5	36.5	45
50		42.4	45.8	46.6	48.5	46.9	46.1	34.1	44.5	42.9	34.1	50
55			38.6	40.8	41.2	40.9	40.7	31.2	38.9	38	32	55
60			33.1	35.1	35.5	36.6	35.9	28.9	34.9	33.8	30	60
65				30.5	30.8	31.8	31.5	26.6	31.4	30	28.1	65
70				26.7	27.3	28	27.8	24.7	27.9	26.8	26.2	70
75				23.7	24.1	24.8	24.6	22.9	24.5	23.8	24	75
80					21.4	22.1	21.7	21.4	21.7	21	21.3	80
85					19.1	19.6	19.3	19.6	19.2	18.5	18.8	85
90						17.5	17.1	17.4	17.1	16.4	16.7	90
95						15.7	15.3	15.6	15.2	14.6	14.8	95
100						14.1	13.6	13.9	13.6	12.9	13.2	100
105							12.2	12.5	12.1	11.4	11.7	105
110							11	11.2	10.8	10.1	10.4	110
115							10	10	9.7	9.2	9.4	115
120								9.2	8.9	8.3	8.5	120
125									8.2	7.6	7.7	125
130										6.9	7	130
135										6.3	6.4	135
140										5.6	5.8	140
145											5.2	145
150											4.6	150

t_270_001_21510_00_000 / t_270_001_11510_00_000

Lifting capacities

Forces de levage

T

42 - 246 ft

360°

48,500 lb

15.8 ft

18.8 ft

85%

	160 ft	174 ft	187 ft	188 ft	199 ft	213 ft	217 ft	226 ft	229 ft	230 ft	237 ft	243 ft	246 ft	
26	86.4													26
28	81.2	65.1												28
30	75.4	71												30
32	69.5	65.4	58.1											32
34	64.9	61	57.6	36.8										34
36	60.9	57.8	54.6	36.4	50.2									36
38	57	53.8	50.7	35.8	47.7	42.2								38
40	53.3	51.3	48.6	35.2	46.1	43.3	30.8							40
45	47	44.7	42.7	33.6	40.2	37.4	30	34.7	33.9	28.1	28.2	25.8	25.1	45
50	41	39.8	38	32	36	33.5	29	30.7	30.6	27.4	27.5	26.1	25.5	50
55	36.8	34.8	33.4	30.5	31.4	29.1	28	26.6	26.5	26.7	25.5	24.7	24.2	55
60	32.4	30.7	29.4	29	27.5	25.4	26	23.2	23.1	24	22.5	21.8	21.4	60
65	28.8	27.1	26	26.9	24.2	22.2	22.9	20.1	20.1	21.1	19.7	19.1	18.6	65
70	25.6	24.1	23	23.9	21.4	19.6	20.3	17.6	17.6	18.6	17.2	16.7	16.3	70
75	22.9	21.5	20.5	21.4	18.9	17.3	18	15.4	15.4	16.4	15.1	14.6	14.2	75
80	20.4	19.2	18.3	19.2	16.7	15.2	15.9	13.4	13.5	14.4	13.2	12.7	12.4	80
85	17.9	17	16.3	17.1	14.8	13.4	14.2	11.7	11.7	12.7	11.6	11.1	10.7	85
90	15.8	14.9	14.3	15.1	13.1	11.7	12.6	10.1	10.2	11.2	10	9.6	9.3	90
95	14	13	12.5	13.3	11.4	10.2	11.1	8.7	8.8	9.8	8.7	8.3	8	95
100	12.3	11.4	10.9	11.6	9.8	8.9	9.7	7.3	7.5	8.5	7.5	7.1	6.8	100
105	10.9	10	9.5	10.2	8.6	7.6	8.6	6.1	6.3	7.4	6.3	6	5.7	105
110	9.7	8.9	8.5	9.1	7.6	6.5	7.5	5	5.2	6.4	5.2	5	4.7	110
115	8.7	8	7.5	8.2	6.7	5.5	6.5	4	4.2	5.4	4.3	3.9	3.7	115
120	7.9	7.1	6.7	7.3	5.8	4.6	5.6	3	3.2	4.5	3.2	2.9	2.5	120
125	7.1	6.4	5.9	6.5	5	3.7	4.7			3.6				125
130	6.4	5.7	5.2	5.8	4.2	2.8	3.9			2.6				130
135	5.8	5	4.5	5.2	3.4		3.1							135
140	5.1	4.2	3.7	4.5	2.6		2.3							140
145	4.5	3.6	3.1	3.8										145
150	3.9	3	2.2	3.2										150
155	3.4	2.4		2.6										155

t_270_001_21510_00_000 / t_270_001_11510_00_000

Lifting heights

Hauteurs de levage

TK/TNZK

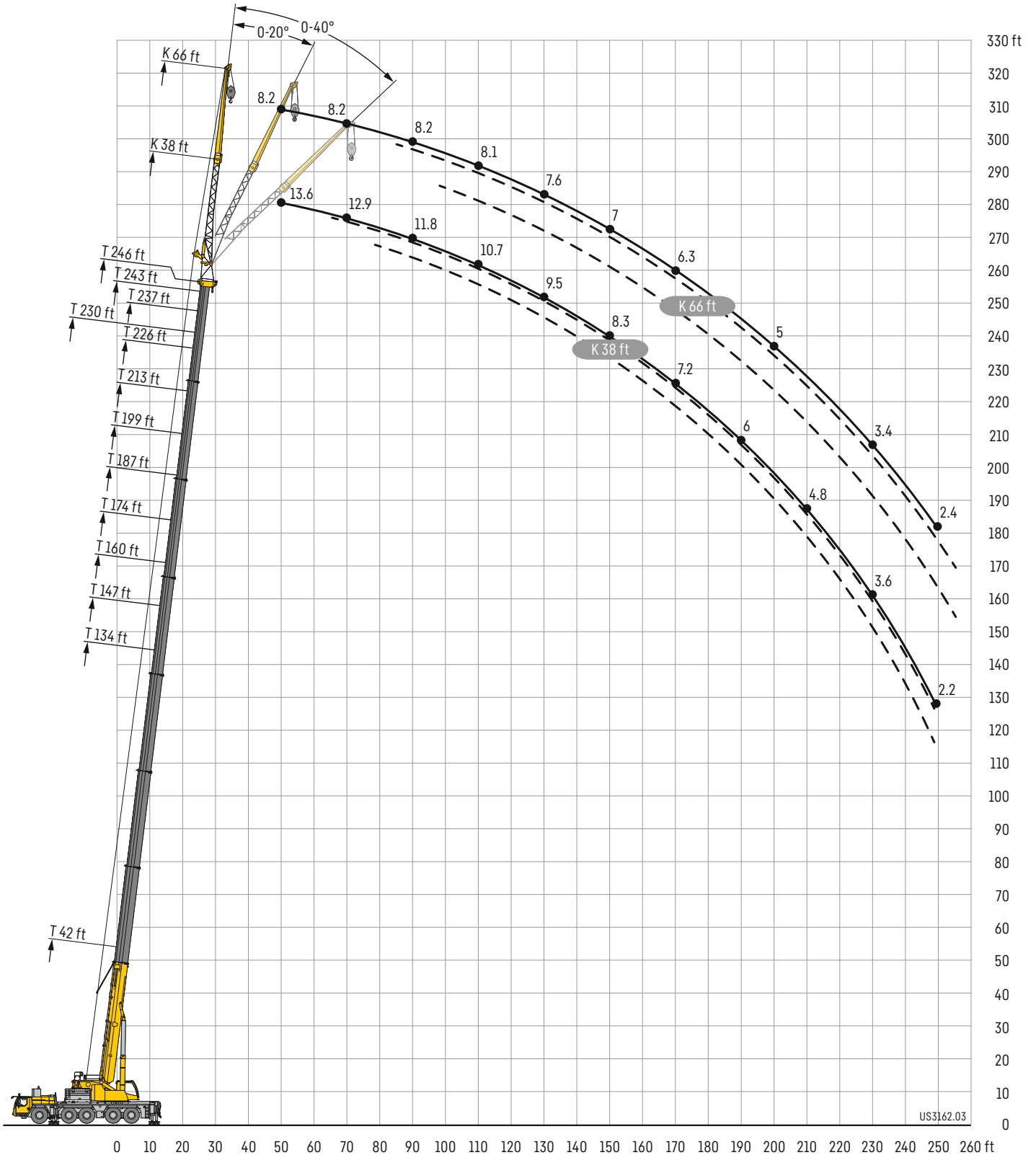

Lifting capacities

Forces de levage

TK/TNZK

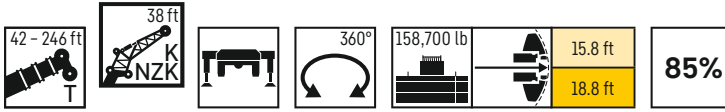

	42 ft			134 ft			147 ft			160 ft			174 ft			187 ft			199 ft			
	38 ft									0°	20°	40°	0°	20°	40°	0°	20°	40°	0°	20°	40°	
	0°	20°	40°	0°	20°	40°	0°	20°	40°													
12	46.1																					12
13	46.1																					13
14	46.1																					14
15	46.1																					15
16	46.1																					16
17	46.1																					17
18	46.1	44.8																				18
19	46.1	43.9																				19
20	46.1	43.1		46.1																		20
22	46.1	41.2		46.1																		22
24	46.1	38.9		46.1			46.1															24
26	46.1	36.9		46.1			46.1			43.2												26
28	45.8	34.9	25.1	46.1			46.1			43												28
30	42.7	33.2	24.2	46.1			46.1			42.8			38.3									30
32	39.4	31.6	23.5	46.1			46			42.5			38.1									32
34	36.4	30.2	22.7	46.1	36.7		45.7			42.2			37.9			33.3						34
36	33.7	28.9	22.1	46.1	36.2		45.3	35.4		41.9			37.7			33.1						36
38	31.5	27.6	21.5	46.1	35.6		44.8	35		41.6			37.5			33			28.3			38
40	29.3	26.5	20.9	46	34.8		44.3	34.5		41.1	33.3		37.2			32.8			28.2			40
45	25.2	24.1	19.7	44.5	32.9	22.7	42.7	33	22.8	39.9	32.2		36.4	30.6		32.3			27.9			45
50	21.9	22	18.6	42.5	31.2	22	41.2	31.3	22.1	38.8	31	22.1	35.6	29.8		31.7	27.9		27.6			50
55	19.3	20.3	17.8	40.1	29.6	21.3	39.7	29.8	21.4	37.7	29.7	21.4	34.7	29	21.3	31.2	27.3	21	27.3	24.9		55
60	17.1	18.9	17.3	37.6	28.2	20.7	37.7	28.5	20.8	36.5	28.4	20.9	33.9	27.9	20.8	30.7	26.7	20.5	27	24.5	20.1	60
65	15.3	17.8	17	35.2	27	20.1	35.6	27.3	20.3	35	27.3	20.3	33.1	26.9	20.3	30.1	26	20.1	26.7	24.1	19.7	65
70	13.8	17	16	32.9	25.8	19.6	33.7	26.2	19.8	33.4	26.2	19.9	32.1	25.9	19.8	29.5	25.2	19.6	26.3	23.6	19.3	70
75				30.7	24.7	19.2	31.7	25.2	19.3	31.7	25.3	19.4	30.9	25	19.4	28.9	24.4	19.2	25.9	23.2	18.9	75
80				28.6	23.7	18.7	29.9	24.2	18.9	30.1	24.4	19	29.7	24.2	19	28.1	23.6	18.9	25.3	22.6	18.6	80
85				26.7	22.9	18.3	28.1	23.3	18.5	28.6	23.5	18.7	28.4	23.5	18.7	27.3	22.9	18.5	24.6	22.1	18.3	85
90				25	22	18	26.4	22.6	18.2	27.1	22.8	18.3	27	22.7	18.3	26.3	22.3	18.2	23.6	21.5	18	90
95				23.5	21.3	17.7	24.8	21.9	17.9	25.6	22.1	18	25.7	22.1	18	25.3	21.7	18	22.6	21	17.8	95
100				22.1	20.6	17.4	23.5	21.1	17.6	24.2	21.5	17.7	24.5	21.4	17.8	24.1	21.2	17.7	21.6	20.5	17.5	100
105				20.9	19.9	17.2	22.2	20.5	17.4	23	20.8	17.5	23.4	20.9	17.5	23.1	20.6	17.5	20.7	20	17.3	105
110				19.8	19.4	17	21.1	19.9	17.2	21.9	20.2	17.3	22.3	20.4	17.3	22	20.1	17.3	19.7	19.4	17.1	110
115				18.8	18.8	16.9	20	19.4	17	20.9	19.8	17.1	21.3	19.9	17.1	21	19.6	17.1	18.8	18.7	17	115
120				17.9	18.4	16.8	19	18.9	16.8	19.9	19.3	16.9	20.5	19.4	17	19.9	19.1	17	17.9	17.9	16.8	120
125				17	17.9	16.7	18.2	18.4	16.8	19.1	18.8	16.8	19.6	19	16.8	19	18.6	16.8	17.1	17.2	16.6	125
130				16.2	17.6	16.7	17.4	18.1	16.7	18.3	18.4	16.7	18.8	18.6	16.7	18.2	18.1	16.7	16.3	16.4	16.2	130
135				15.5	17.3	16.7	16.7	17.7	16.7	17.5	18.1	16.7	18.1	18.2	16.6	17.3	17.4	16.5	15.6	15.7	15.6	135
140				14.9	17	16.7	16	17.4	16.7	16.8	17.7	16.6	17.3	17.7	16.6	16.5	16.6	16.1	14.9	14.9	15	140
145				14.3	16.8	16.7	15.3	17.1	16.7	16.2	17.3	16.6	16.1	17	16.5	15.7	15.9	15.8	14.2	14.3	14.5	145
150				13.7	16.6	13.1	14.8	16.8	16.7	15.5	16.3	16.3	14.8	15.6	16.1	14.6	15.1	15.3	13.5	13.6	13.9	150
155				13.3	16.6	8	14.2	16	16.2	14.9	15.5	15.8	13.8	14.4	14.8	13.5	14.3	14.6	12.9	13	13.3	155
160				12.8	15.4		13.7	14.9	13.6	13.9	14.5	14.7	13.1	13.3	13.6	12.4	13.1	13.6	12.3	12.5	12.7	160
165				9.1			13.3	13.8	9.3	12.8	13.4	13.6	12.4	12.7	12.8	11.3	12	12.5	11.4	11.9	12.1	165
170							12.3	12.8		11.9	12.3	12.5	11.7	12	12.2	10.7	11	11.4	10.5	11.2	11.5	170
175							9.3			11	11.4	10.9	10.8	11.2	11.4	10.2	10.4	10.5	9.7	10.3	10.6	175
180										10.2	10.5	7.7	10	10.4	10.5	9.8	9.9	10.1	9.1	9.5	9.7	180
185										8.8	9.6		9.3	9.6	9.7	9.3	9.5	9.7	8.8	8.9	9.1	185
190										5.9			8.7	9	8.6	8.7	9.1	9.2	8.5	8.6	8.7	190
195													8.1	8.3		8.2	8.5	8.5	8.1	8.2	8.4	195
200													7.2			7.7	7.9	7.9	7.8	7.9	8	200
205													6.3			7.5	7.6	7.1	7.2	7.6	7.6	205
210																7.3	7.4		6.7	7	7	210
215																6.5			6.1	6.4	6.4	215
220																			5.9	6		220
225																			5.6			225
230																						230

t 270_002_11001_00_00 / t 270_002_12001_00_000

Lifting capacities

Forces de levage

TK/TNZK

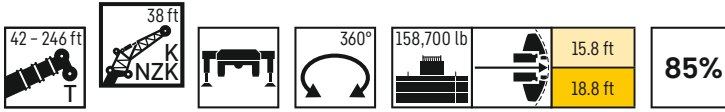

	213 ft			226 ft			230 ft			237 ft			243 ft			246 ft			
	38 ft																		
	0°	20°	40°	0°	20°	40°	0°	20°	40°	0°	20°	40°	0°	20°	40°	0°	20°	40°	
38	20.8																		38
40	23.9																		40
45	23.7			19			15.5			15			14.1						45
50	23.6			19			15.3			14.8			14			13.6			50
55	23.4	20.1		18.9			15			14.6			13.8			13.5			55
60	23.2	21.9		18.8	18.3		14.8	14.7		14.4	14.4		13.6			13.3			60
65	23	21.7		18.5	18		14.5	14.4		14.2	14.1		13.4	13.4		13.1	13.1		65
70	22.8	21.4	18.7	18.1	17.6	17.2	14.2	14	14.1	13.9	13.7		13.2	13.1		12.9	12.8		70
75	22.4	21.1	18.4	17.7	17.1	16.8	13.9	13.7	13.8	13.6	13.4	13.5	12.9	12.8	12.9	12.7	12.6	12.7	75
80	21.8	20.5	18.2	17.2	16.5	16.2	13.5	13.3	13.4	13.3	13.1	13.2	12.6	12.5	12.6	12.4	12.3	12.4	80
85	21.1	19.9	17.9	16.7	16	15.7	13.1	12.9	13	12.9	12.7	12.8	12.3	12.2	12.3	12.1	12	12.1	85
90	20.3	19.2	17.7	16.2	15.5	15.2	12.8	12.5	12.6	12.6	12.4	12.4	12	11.9	12	11.8	11.7	11.8	90
95	19.6	18.6	17.4	15.7	15	14.8	12.4	12.2	12.2	12.2	12	12.1	11.7	11.6	11.7	11.5	11.4	11.5	95
100	18.9	18	17.2	15.3	14.6	14.3	12	11.8	11.9	11.9	11.7	11.7	11.4	11.2	11.3	11.2	11.1	11.2	100
105	18.2	17.4	16.9	14.8	14.1	13.9	11.6	11.4	11.5	11.5	11.3	11.4	11.1	10.9	11	10.9	10.8	10.9	105
110	17.5	16.9	16.5	14.3	13.7	13.5	11.3	11.1	11.1	11.2	11	11.1	10.8	10.6	10.7	10.7	10.5	10.6	110
115	16.8	16.3	16	13.8	13.3	13.1	10.9	10.7	10.8	10.9	10.7	10.7	10.5	10.3	10.4	10.4	10.2	10.3	115
120	16.2	15.8	15.5	13.4	12.9	12.7	10.6	10.4	10.5	10.5	10.4	10.4	10.2	10.1	10.1	10.1	10	10	120
125	15.5	15.3	15.1	13	12.5	12.3	10.2	10.1	10.2	10.2	10	10.1	9.9	9.8	9.9	9.8	9.7	9.8	125
130	14.8	14.7	14.6	12.6	12.1	12	9.8	9.8	9.9	9.9	9.8	9.9	9.6	9.6	9.7	9.5	9.5	9.6	130
135	14.1	14.2	14.2	12.2	11.8	11.7	9.5	9.6	9.6	9.7	9.6	9.6	9.3	9.3	9.4	9.2	9.2	9.4	135
140	13.5	13.6	13.7	11.8	11.5	11.4	9.1	9.3	9.4	9.4	9.3	9.4	9	9.1	9.2	8.9	9	9.1	140
145	12.9	13	13.2	11.4	11.1	11.1	8.8	9	9.1	9.2	9.1	9.2	8.7	8.8	8.9	8.6	8.7	8.9	145
150	12.3	12.4	12.6	11	10.8	10.8	8.5	8.6	8.8	9	8.9	9	8.4	8.5	8.7	8.3	8.5	8.6	150
155	11.7	11.9	12.1	10.7	10.5	10.5	8.1	8.3	8.5	8.7	8.7	8.8	8.1	8.2	8.4	8	8.2	8.4	155
160	11.2	11.4	11.6	10.3	10.2	10.3	7.8	8	8.2	8.5	8.5	8.6	7.8	8	8.1	7.8	7.9	8.1	160
165	10.7	10.9	11.1	9.9	9.9	10	7.5	7.7	7.9	8.3	8.3	8.4	7.5	7.7	7.9	7.5	7.7	7.8	165
170	10.3	10.4	10.6	9.6	9.6	9.7	7.2	7.4	7.6	8.1	8.1	8.2	7.3	7.4	7.6	7.2	7.4	7.5	170
175	9.8	10	10.1	9.2	9.3	9.5	6.9	7.1	7.3	7.8	7.9	8	7	7.1	7.3	6.9	7.1	7.3	175
180	9.2	9.6	9.7	8.9	9	9.2	6.7	6.8	7	7.6	7.7	7.8	6.7	6.9	7	6.6	6.8	7	180
185	8.6	9	9.3	8.6	8.7	8.9	6.4	6.6	6.7	7.4	7.5	7.6	6.5	6.6	6.8	6.3	6.5	6.7	185
190	8.1	8.4	8.7	8.3	8.4	8.6	6.1	6.3	6.4	7.2	7.3	7.4	6.2	6.4	6.5	6	6.2	6.4	190
195	7.8	8	8.1	7.9	8.2	8.3	5.9	6	6.1	7	7.1	7.2	6	6.1	6.3	5.7	5.9	6.1	195
200	7.5	7.7	7.8	7.4	7.8	8	5.6	5.8	5.9	6.9	6.9	7	5.7	5.9	6	5.4	5.6	5.8	200
205	7.3	7.4	7.5	6.8	7.2	7.4	5.3	5.5	5.6	6.7	6.7	6.8	5.5	5.6	5.8	5.1	5.3	5.5	205
210	7	7.1	7.2	6.2	6.7	6.9	5.1	5.2	5.3	6.3	6.6	6.6	5.2	5.4	5.5	4.8	5	5.1	210
215	6.7	6.8	6.9	5.7	6.1	6.3	4.9	5	5.1	5.9	6.3	6.5	5	5.2	5.3	4.5	4.7	4.9	215
220	6.2	6.5	6.5	5.1	5.5	5.7	4.6	4.8	4.8	5.3	5.7	5.9	4.8	5	5	4.2	4.4	4.6	220
225	5.7	6	6	4.6	5	5.1	4.4	4.5	4.6	4.8	5.2	5.4	4.5	4.7	4.8	3.9	4.1	4.2	225
230	5.2	5.4		4.2	4.5	4.5	4.2	4.3	4.3	4.3	4.7	4.8	4.1	4.5	4.6	3.6	3.8	3.9	230
235	4.8	5		3.7	4	4	4	4.1	4.1	3.9	4.2	4.3	3.7	4	4.1	3.3	3.5	3.6	235
240	3.4			3.3	3.5	3.5	3.8	3.9	3.9	3.4	3.7	3.8	3.2	3.6	3.6	3	3.3	3.3	240
245				2.9	3		3.6	3.7	3.7	3	3.3	3.3	2.8	3.1	3.2	2.6	2.9	3	245
250				2.2			3.4	3.5		2.6	2.8	2.8	2.4	2.7	2.7	2.2	2.5	2.5	250
255							2.7			2.2	2.4			2.3	2.2				255

t_270_002_11001_00_000 / t_270_002_12001_00_000

Lifting capacities

Forces de levage

TK/TNZK

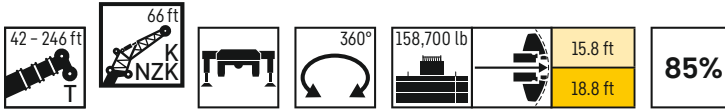

	42 ft			134 ft			147 ft			160 ft			174 ft			187 ft			199 ft			
	0°	20°	40°	0°	20°	40°	0°	20°	40°	0°	20°	40°	0°	20°	40°	0°	20°	40°	0°	20°	40°	
10	21.2																					10
11	21.2																					11
12	21.2																					12
13	21.2																					13
14	21.2																					14
15	21.2																					15
16	21.2																					16
17	21.2																					17
18	21.2																					18
19	21.2																					19
20	21.2																					20
22	21.1																					22
24	20.8			18.3																		24
26	20.4			18.3			17.8															26
28	19.8			18.3			17.8			17.3												28
30	19.2			18.3			17.8			17.3												30
32	18.6	14.7		18.3			17.8			17.3			16.3									32
34	18.1	14.4		18.3			17.8			17.3			16.3		15.3							34
36	17.5	14		18.3			17.8			17.2			16.3		15.3							36
38	16.9	13.6		18.3			17.8			17.2			16.3		15.2				13.9			38
40	16.4	13.3		18.2			17.8			17.1			16.2		15.2				13.9			40
45	15.2	12.3		17.9			17.5			16.9			16.1		15				13.8			45
50	13.9	11.5	9.5	17.4	12.9		17.1	12.8		16.6			15.9		14.9				13.7			50
55	12.5	10.8	9.2	16.8	12.4		16.7	12.3		16.3	12.2		15.6	12	14.7				13.5			55
60	11.1	10.2	8.8	16.3	11.9		16.2	11.9		15.9	11.8		15.3	11.6	14.5	11.3			13.3			60
65	10	9.6	8.5	15.6	11.4	9	15.7	11.4		15.4	11.4		14.9	11.2	14.2	10.9			13.1	10.5		65
70	9.1	9.2	8.3	15	11	8.8	15.1	11.1	8.8	14.9	11	8.8	14.5	10.9	13.8	10.6			12.9	10.2		70
75	8.4	8.8	8.1	14.4	10.6	8.6	14.5	10.7	8.6	14.4	10.7	8.6	14	10.5	13.4	10.3	8.5		12.6	10		75
80	7.8	8.5	7.9	13.8	10.3	8.5	13.9	10.3	8.5	13.8	10.3	8.5	13.6	10.3	13.1	10.1	8.3		12.3	9.8	8.2	80
85	7.3	8.3	7.8	13.2	10	8.4	13.4	10.1	8.4	13.4	10	8.4	13.1	10	12.7	9.8	8.2		12	9.6	8.1	85
90	6.7	8	7.8	12.6	9.7	8.2	12.8	9.8	8.2	12.9	9.8	8.2	12.7	9.8	12.3	9.6	8.1		11.7	9.4	8	90
95	6.3	7.8	7.8	12.1	9.5	8.1	12.3	9.6	8.1	12.4	9.6	8.1	12.3	9.5	11.9	9.4	8		11.4	9.2	7.9	95
100	6	7.7		11.5	9.3	8	11.9	9.4	8	11.9	9.4	8	11.9	9.4	11.6	9.2	7.9		11.1	9.1	7.8	100
105				10.9	9.1	7.9	11.4	9.1	7.9	11.5	9.2	7.9	11.5	9.2	11.2	9.1	7.8		10.8	8.9	7.7	105
110				10.3	8.9	7.8	10.8	9	7.8	11.1	9	7.8	11.1	9	10.9	8.9	7.8		10.5	8.8	7.7	110
115				9.7	8.7	7.8	10.3	8.8	7.8	10.6	8.8	7.8	10.7	8.8	10.6	8.8	7.7		10.3	8.6	7.6	115
120				9.3	8.5	7.7	9.8	8.6	7.7	10.2	8.7	7.7	10.3	8.7	10.3	8.6	7.6		10	8.5	7.5	120
125				8.9	8.4	7.6	9.4	8.5	7.6	9.8	8.5	7.6	9.9	8.5	9.9	8.5	7.6		9.7	8.4	7.5	125
130				8.5	8.2	7.6	9	8.4	7.6	9.3	8.4	7.6	9.6	8.4	9.6	8.4	7.5		9.5	8.2	7.4	130
135				8.2	8.1	7.6	8.6	8.2	7.6	9	8.3	7.5	9.3	8.3	9.3	8.2	7.5		9.2	8.1	7.4	135
140				7.9	8	7.6	8.3	8.1	7.5	8.7	8.2	7.5	8.9	8.1	9	8.1	7.4		9	8	7.4	140
145				7.6	7.9	7.6	8	8	7.5	8.4	8	7.5	8.6	8	8.8	8	7.4		8.7	7.9	7.3	145
150				7.3	7.8	7.6	7.8	7.9	7.5	8.1	7.9	7.5	8.4	8	8.5	7.9	7.4		8.5	7.8	7.3	150
155				7.1	7.7	7.6	7.5	7.8	7.5	7.8	7.8	7.5	8.1	7.8	8.2	7.8	7.3		8.3	7.8	7.3	155
160				6.9	7.7	7.6	7.3	7.7	7.5	7.6	7.8	7.5	7.8	7.8	8	7.7	7.3		8.1	7.7	7.3	160
165				6.7	7.6	7.6	7	7.6	7.5	7.4	7.7	7.5	7.6	7.7	7.4	7.8	7.3		7.8	7.6	7.3	165
170				6.5	7.6	7.6	6.8	7.6	7.5	7.2	7.6	7.5	7.4	7.6	7.4	7.6	7.3		7.6	7.5	7.3	170
175				6.3	7.6	7.6	6.6	7.6	7.5	6.9	7.6	7.5	7.2	7.6	7.4	7.4	7.3		7.5	7.5	7.3	175
180				6.1	7.6	7.6	6.4	7.6	7.5	6.8	7.5	7.5	7	7.5	7.4	7.2	7.5		7.3	7.4	7.3	180
185				6	7.6		6.3	7.6	7.5	6.6	7.5	7.5	6.8	7.5	7.4	7	7.4		7.1	7.4	7.3	185
190				5.8			6.1	7.6	7.5	6.4	7.5	7.5	6.6	7.4	7.4	6.8	7.4		7	7.4	7.3	190
195							6	7.6	7.5	6.3	7.5	7.5	6.5	7.4	7.4	6.7	7.4		6.8	7.3	7.3	195
200							5.9	7.6		6.1	7.5	7.5	6.4	7.4	7.4	6.5	7.4		6.6	7.3	7.3	200
205							5.5			6	7.5	7.5	6.2	7.4	7.4	6.4	7.3		6.5	7.3	7.3	205
210										5.9	7.5		6.1	7.4	7.4	6.2	7.3		6.3	7.1	7.2	210
215										5.7			6	7.3	7.3	6.1	7.2		6.2	6.8	6.9	215
220													5.9	6.7	6	6	6.9		6.1	6.5	6.7	220
225													5.5	6.1		5.8	6.3		6	6.3	6.4	225
230													5.4			5.7	5.8		5.5	6	6.1	230
235																5.6	5.7		5.1	5.6	5.6	235
240																5.4			4.8	5	5	240
245																3.7			4.6	4.7		245
250																			4.4	4.5		250
255																			3.4			255

t_270_002_14001_00_000 / t_270_002_13001_00_000

Lifting capacities

Forces de levage

TK/TNZK

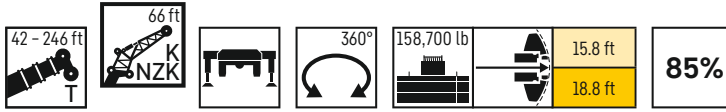

	213 ft			226 ft			230 ft			237 ft			243 ft			246 ft				
	66 ft																			
	0°	20°	40°	0°	20°	40°	0°	20°	40°	0°	20°	40°	0°	20°	40°	0°	20°	40°*		
45	12.3			10.7															45	
50	12.2			10.6			9.6			9.2			8.5					8.2	50	
55	12			10.5			9.5			9.2			8.5					8.2	55	
60	11.9			10.4			9.5			9.2			8.5					8.2	60	
65	11.8			10.3			9.4			9.2			8.5					8.2	65	
70	11.6	9.8		10.2			9.4			9.2			8.5					8.2	70	
75	11.5	9.6		10.1	9.1		9.3	8.6		9.1			8.5					8.2	75	
80	11.3	9.4		10	8.9		9.2	8.5		9.1	8.4		8.5	8.2				8.2	80	
85	11	9.2	7.9	10	8.8		9.1	8.4		9	8.3		8.5	8.1				8.2	85	
90	10.8	9.1	7.9	9.8	8.6	7.6	9.1	8.3		8.9	8.2		8.5	8				8.2	90	
95	10.6	8.9	7.8	9.7	8.5	7.6	9	8.2	7.4	8.9	8.1	7.4	8.5	8				8.2	95	
100	10.4	8.7	7.7	9.6	8.4	7.5	8.9	8.1	7.3	8.8	8	7.3	8.4	7.9	7.2			8.2	100	
105	10.1	8.6	7.6	9.4	8.3	7.4	8.8	8	7.3	8.7	7.9	7.3	8.3	7.8	7.2			8.1	105	
110	9.9	8.5	7.5	9.3	8.2	7.4	8.6	7.9	7.2	8.5	7.8	7.2	8.2	7.7	7.1			8.1	110	
115	9.8	8.4	7.5	9.2	8.1	7.3	8.4	7.8	7.2	8.4	7.8	7.1	8.1	7.6	7.1			8	115	
120	9.6	8.3	7.4	9	8	7.3	8.3	7.7	7.1	8.2	7.7	7.1	7.9	7.5	7.1			7.8	120	
125	9.4	8.1	7.4	8.9	7.9	7.2	8.1	7.6	7.1	8	7.6	7.1	7.8	7.5	7			7.7	125	
130	9.2	8	7.3	8.8	7.8	7.2	7.9	7.6	7.1	7.9	7.5	7.1	7.6	7.4	7			7.6	130	
135	9	7.9	7.3	8.6	7.7	7.2	7.7	7.5	7.1	7.7	7.4	7	7.5	7.3	7			7.4	135	
140	8.8	7.9	7.3	8.5	7.6	7.2	7.6	7.4	7.1	7.5	7.4	7	7.3	7.2	7			7.3	140	
145	8.6	7.8	7.2	8.3	7.6	7.1	7.4	7.3	7.1	7.4	7.3	7	7.2	7.1	6.9			7.1	145	
150	8.4	7.7	7.2	8.2	7.5	7.1	7.2	7.2	7	7.2	7.2	7	7	7	6.9			7	150	
155	8.2	7.6	7.2	8	7.4	7.1	7	7	7	7	7	7	6.9	6.9	6.9			6.8	155	
160	8	7.5	7.2	7.8	7.4	7.1	6.8	6.9	6.9	6.9	6.9	6.9	6.7	6.7	6.8			6.6	160	
165	7.8	7.5	7.2	7.6	7.3	7.1	6.6	6.7	6.8	6.7	6.7	6.8	6.5	6.6	6.7			6.5	165	
170	7.6	7.4	7.2	7.4	7.3	7.1	6.4	6.5	6.7	6.6	6.6	6.7	6.3	6.4	6.6			6.3	170	
175	7.4	7.4	7.2	7.3	7.2	7.1	6.2	6.4	6.5	6.4	6.4	6.6	6.1	6.3	6.5			6.1	175	
180	7.2	7.3	7.2	7.2	7.2	7.1	6	6.2	6.4	6.3	6.3	6.4	5.9	6.1	6.3			5.9	180	
185	7.1	7.3	7.2	7	7.1	7.1	5.7	6	6.2	6.1	6.2	6.3	5.7	5.9	6.2			5.7	185	
190	7	7.3	7.2	6.9	7	7.1	5.5	5.8	6	6	6	6.2	5.5	5.7	6			5.4	190	
195	6.8	7.2	7.2	6.8	7	7.1	5.3	5.6	5.8	5.8	5.9	6	5.3	5.6	5.8			5.2	195	
200	6.7	7.2	7.2	6.7	6.9	7	5.1	5.4	5.6	5.7	5.8	5.9	5.1	5.4	5.6			5	200	
205	6.6	7.2	7.2	6.5	6.8	6.9	4.9	5.1	5.4	5.6	5.6	5.8	4.9	5.2	5.4			4.7	205	
210	6.4	7.1	7.2	6.4	6.6	6.8	4.7	4.9	5.1	5.4	5.5	5.7	4.7	5	5.2			4.5	210	
215	6.2	6.8	7.1	6.2	6.5	6.6	4.5	4.7	4.9	5.3	5.4	5.6	4.5	4.8	5			4.2	215	
220	6	6.3	6.6	5.8	6.3	6.5	4.3	4.5	4.7	5.2	5.3	5.4	4.3	4.6	4.8			3.9	220	
225	5.8	6	6.1	5.3	6.1	6.3	4.1	4.3	4.5	5	5.1	5.3	4.1	4.4	4.6			3.6	225	
230	5.5	5.8	5.9	4.8	5.6	5.9	3.9	4.1	4.3	4.8	5	5.2	4	4.2	4.4			3.4	230	
235	5.3	5.5	5.6	4.4	5	5.4	3.7	3.9	4	4.5	4.9	5	3.8	4	4.2			3.1	235	
240	5	5.3	5.4	3.9	4.5	4.8	3.4	3.7	3.8	4	4.7	4.9	3.5	3.8	4			2.9	240	
245	4.5	5	5.1	3.5	4.1	4.3	3.2	3.5	3.6	3.6	4.2	4.5	3.3	3.6	3.7			2.6	245	
250	4.1	4.5	4.5	3.1	3.6	3.8	3	3.3	3.4	3.2	3.8	4	3	3.4	3.5			2.4	250	
255	3.8	4.1	4	2.7	3.2	3.3	2.8	3.1	3.1	2.8	3.3	3.5	2.6	3.2	3.3			2.5	255	
260	3.4	3.7		2.3	2.8	2.8	2.7	2.8	2.9	2.4	2.9	3.1	2.2	2.7	2.9			2.3	260	
265	2.7				2.3	2.3	2.5	2.6	2.6		2.5	2.6		2.3	2.5				2.3	265
270							2.3	2.4	2.4											270
275								2.2												275

* only possible in TNZK mode - uniquement possible en cas de fonctionnement de la pointe pliante hydraulique de la flèche télescopique (TNZK)

t_270_002_14001_00_000 / t_270_002_13001_00_000

Lifting heights

Hauteurs de levage

TVK/TVNZK

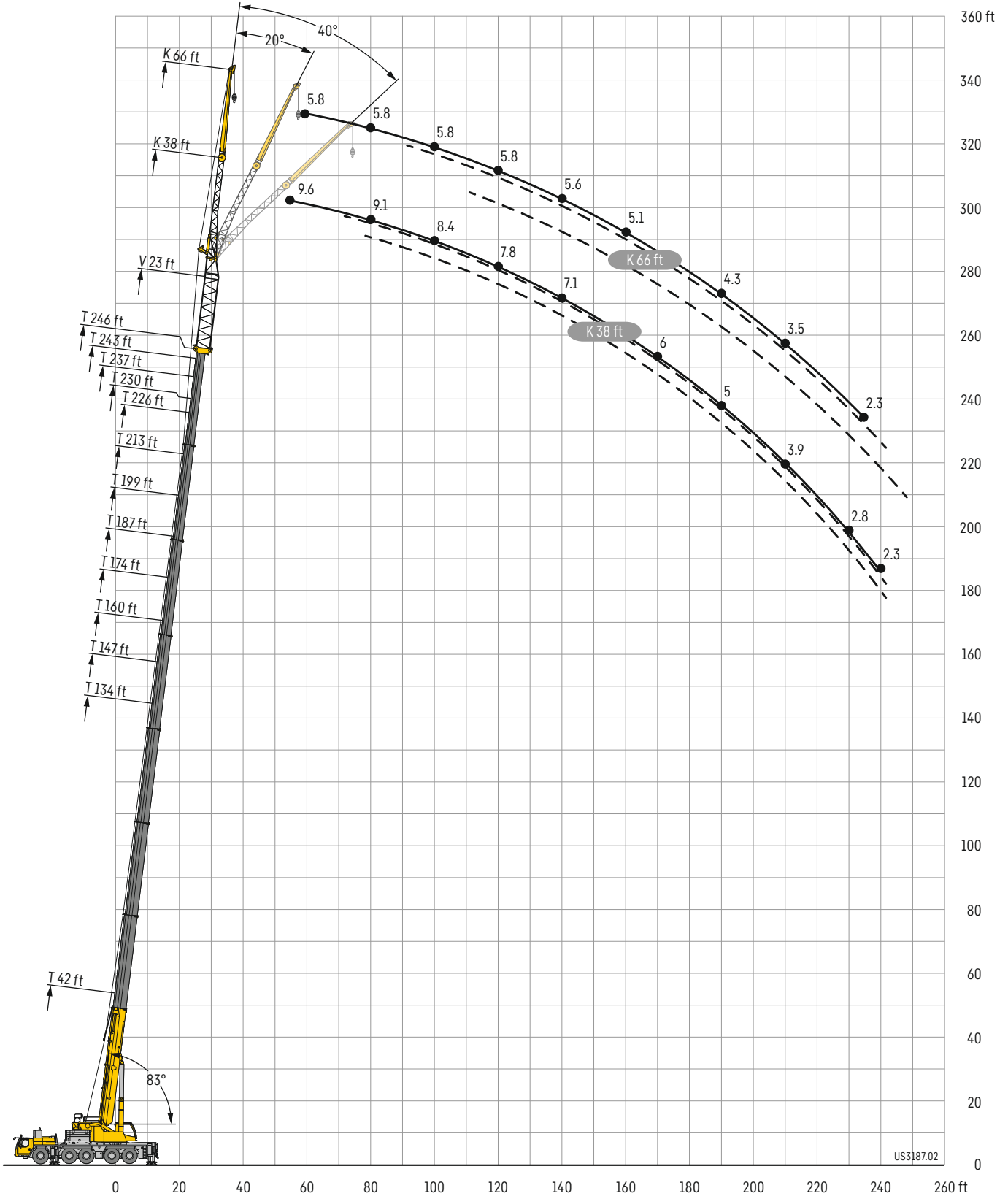

Lifting capacities

Forces de levage

TVK/TVNZK

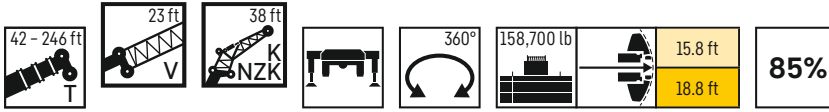

	42 ft + 23 ft			134 ft + 23 ft			147 ft + 23 ft			160 ft + 23 ft			174 ft + 23 ft			187 ft + 23 ft			199 ft + 23 ft				
	38 ft																						
	0°	20°	40°	0°	20°	40°	0°	20°	40°	0°	20°	40°	0°	20°	40°	0°	20°	40°	0°	20°	40°		
10	46.1																					10	
11	46.1																					11	
12	46.1																					12	
13	46.1																					13	
14	46.1																					14	
15	46.1																					15	
16	46.1																					16	
17	46.1																					17	
18	46.1																					18	
19	46.1																					19	
20	46.1																					20	
22	46.1	42																				22	
24	46.1	40.9																				24	
26	46	39.9		40.2																		26	
28	44.7	38.3		39.7			37.1															28	
30	43.4	36.8		39.3			36.8															30	
32	41.9	35.3	24.5	38.8			36.5			33.5												32	
34	40.3	34	23.8	38.3			36.1			33.2												34	
36	38.7	32.7	23.3	37.8			35.7			32.9			29.5									36	
38	37	31.4	22.7	37.2			35.2			32.5			29.2			25.5						38	
40	35.3	30.2	22.2	36.6	31.7		34.7			32.2			28.9			25.4				20.3		40	
45	31.1	27.3	21.1	35	30.3		33.5	29.4		31.2	27.9		28.3			24.9				20.1		45	
50	27.6	24.7	20.1	33.5	29	21.9	32.2	28.2	21.9	30.2	26.9		27.6	25.1		24.4				19.8		50	
55	24.8	22.4	19.3	32	27.7	21.3	31	27.1	21.3	29.2	26	21.3	26.8	24.4		23.9	22.3			19.6	18.8	55	
60	22.4	20.6	18.5	30.6	26.5	20.8	29.7	26.1	20.8	28.2	25.1	20.7	26.1	23.7	20.5	23.4	21.8			19.3	18.5	60	
65	20.4	18.9	17.8	29.3	25.2	20.2	28.6	25.1	20.3	27.3	24.3	20.2	25.3	23	20.1	22.9	21.2	19.7		19	18.2	65	
70	18.6	17.5	16.8	28	24	19.7	27.5	24	19.8	26.4	23.5	19.8	24.6	22.3	19.6	22.4	20.7	19.3		18.7	17.9	17	70
75	17.1	16.2	15.7	26.8	22.9	19.3	26.4	23	19.4	25.5	22.7	19.4	23.9	21.7	19.2	21.9	20.2	18.8		18.4	17.6	16.7	75
80	15.7	15.1	14.8	25.7	21.9	18.9	25.4	22	19	24.6	21.8	19	23.3	21	18.9	21.4	19.7	18.3		18.1	17.2	16.4	80
85	14.6	14.1	14	24.5	20.9	18.5	24.5	21.1	18.6	23.8	21	18.6	22.6	20.4	18.4	20.9	19.3	17.8		17.8	16.9	16.1	85
90	13.5	13.2	13.4	23.4	20	18	23.6	20.3	18.2	23	20.2	18.2	21.9	19.7	17.9	20.4	18.8	17.3		17.4	16.6	15.7	90
95	12.6	12.6		22.2	19.2	17.5	22.6	19.5	17.7	22.3	19.4	17.6	21.3	19.1	17.3	19.9	18.3	16.8		17.1	16.3	15.4	95
100				21.1	18.5	16.9	21.7	18.7	17.1	21.5	18.7	17.1	20.7	18.4	16.9	19.4	17.8	16.4		16.6	16	15.1	100
105				20.2	17.7	16.4	20.7	18.1	16.6	20.7	18.1	16.6	20.1	17.8	16.4	18.9	17.2	16		16.2	15.7	14.8	105
110				19.3	17.1	15.9	19.9	17.4	16.2	20	17.5	16.2	19.5	17.3	16	18.4	16.8	15.6		15.7	15.2	14.5	110
115				18.5	16.5	15.5	19.1	16.8	15.7	19.2	17	15.7	18.9	16.7	15.6	17.8	16.3	15.2		15.2	14.7	14.2	115
120				17.8	15.9	15	18.3	16.3	15.3	18.5	16.4	15.4	18.3	16.3	15.2	17.2	15.9	14.9		14.6	14.3	13.9	120
125				17	15.4	14.6	17.6	15.8	14.9	17.8	15.9	15	17.7	15.8	14.9	16.5	15.4	14.6		14.1	13.8	13.6	125
130				16.4	14.9	14.3	17	15.3	14.5	17.2	15.5	14.6	17.1	15.4	14.5	15.7	15	14.3		13.6	13.4	13.2	130
135				15.8	14.4	14	16.3	14.8	14.2	16.6	15	14.3	16.6	15	14.2	15	14.6	14		13	12.9	12.8	135
140				15.2	14	13.6	15.8	14.4	13.9	16.1	14.6	14	16	14.6	13.9	14.3	14.2	13.8		12.5	12.4	12.4	140
145				14.7	13.6	13.4	15.2	14	13.6	15.6	14.2	13.7	15.5	14.2	13.7	13.6	13.7	13.5		12	12	12	145
150				14.2	13.3	13.1	14.7	13.6	13.3	15	13.8	13.4	14.8	13.9	13.4	13	13.1	13.1		11.5	11.5	11.6	150
155				13.7	12.9	12.9	14.3	13.3	13.1	14.5	13.5	13.2	13.9	13.5	13.2	12.4	12.6	12.7		11	11.1	11.2	155
160				13.3	12.6	12.7	13.8	13	12.9	13.3	13.2	13	12.8	13.1	13	11.8	12	12.1		10.5	10.6	10.8	160
165				12.9	12.4	12.6	13.4	12.7	12.7	12.4	12.8	12.8	11.8	12.5	12.6	11.3	11.4	11.6		10	10.2	10.4	165
170				12.5	12.1	11.9	12.7	12.4	12.5	11.8	12	12.2	10.8	11.5	11.9	10.6	10.9	11.1		9.6	9.8	10	170
175				12.2	11.9	9.1	11.9	12.1	12.3	11.2	11.4	11.6	9.9	10.5	10.9	9.7	10.3	10.6		9.3	9.4	9.6	175
180				11.7	11.8		11	11.4	11.5	10.4	10.8	11	9.5	9.7	10	9	9.5	9.9		8.9	9.1	9.2	180
185				8.9			10.2	10.5	9.8	9.7	10	10.2	9.1	9.3	9.4	8.4	8.9	9.2		8.5	8.8	8.9	185
190							9.6	9.8		9.1	9.4	9.5	8.7	8.9	9	8	8.2	8.5		8	8.4	8.6	190
195							8.1			8.5	8.8	8.8	8.2	8.5	8.7	7.7	7.8	7.9		7.4	7.9	8.1	195
200							5.3			7.9	8.2	8.1	7.6	8	8.1	7.3	7.5	7.6		6.9	7.3	7.5	200
205										7.3	7.5		7	7.4	7.4	7	7.2	7.3		6.6	6.8	6.9	205
210										5.4			6.5	6.8	6.8	6.5	6.8	6.9		6.4	6.5	6.6	210
215													5.9	6.2		5.9	6.3	6.3		6.1	6.2	6.3	215
220													5.3	5.4		5.7	5.7	5.8		5.8	6	6	220
225													5.2			5.5	5.6	5.6		5.3	5.6	5.7	225
230																5.4	5.4			4.8	5.1	5.1	230
235																5.2				4.5	4.6	4.6	235
240																3.5				4.3	4.4		240
245																				4.1	4.2		245
250																					3.2		250

t_270_003_12001_00_000 / t_270_003_11001_00_000

Lifting capacities

Forces de levage

TVK/TVNZK



	213 ft + 23 ft			226 ft + 23 ft			230 ft + 23 ft			237 ft + 23 ft			243 ft + 23 ft			246 ft + 23 ft			
	38 ft																		
	0°	20°	40°	0°	20°	40°	0°	20°	40°	0°	20°	40°	0°	20°	40°	0°	20°	40°	
45	16.7																		45
50	16.6			13.5			10.8			10.5			9.9						50
55	16.4			13.5			10.7			10.3			9.8			9.6			55
60	16.3	15.9		13.4			10.5			10.2			9.7			9.5			60
65	16.1	15.7		13.3	12.9		10.4	10.3		10.1	10.1		9.6			9.4			65
70	15.9	15.5	14.6	13.1	12.7		10.2	10.1		10	9.9		9.5	9.5		9.3	9.3		70
75	15.7	15.3	14.4	12.8	12.5	12.1	10	9.9	10	9.8	9.8		9.4	9.4		9.2	9.2		75
80	15.5	15	14.2	12.6	12.2	11.8	9.8	9.7	9.8	9.7	9.6	9.6	9.3	9.2	9.3	9.1	9.1	9.1	80
85	15.1	14.5	14	12.3	11.9	11.5	9.7	9.6	9.6	9.5	9.4	9.4	9.1	9.1	9.1	9	8.9	9	85
90	14.6	14.1	13.7	12	11.5	11.2	9.5	9.4	9.4	9.3	9.2	9.3	8.9	8.9	9	8.8	8.8	8.8	90
95	14.2	13.6	13.4	11.6	11.2	11	9.3	9.2	9.2	9.1	9.1	9.1	8.8	8.8	8.8	8.6	8.6	8.7	95
100	13.7	13.2	13	11.3	10.9	10.6	9	9	9	8.9	8.9	8.9	8.6	8.6	8.6	8.4	8.4	8.5	100
105	13.3	12.8	12.6	10.9	10.6	10.3	8.8	8.8	8.8	8.7	8.7	8.7	8.4	8.4	8.5	8.3	8.3	8.4	105
110	12.8	12.4	12.2	10.6	10.3	10.1	8.6	8.6	8.6	8.5	8.5	8.5	8.2	8.2	8.3	8.1	8.1	8.2	110
115	12.4	12	11.8	10.3	10	9.8	8.4	8.3	8.4	8.3	8.3	8.4	8.1	8	8.1	7.9	7.9	8	115
120	12	11.6	11.4	9.9	9.7	9.6	8.2	8.2	8.2	8.1	8.1	8.2	7.9	7.9	7.9	7.8	7.8	7.8	120
125	11.6	11.2	11.1	9.6	9.4	9.4	8	8	8	7.9	7.9	8	7.7	7.7	7.7	7.6	7.6	7.7	125
130	11.2	10.9	10.7	9.4	9.2	9.2	7.8	7.7	7.8	7.7	7.7	7.8	7.5	7.5	7.6	7.4	7.4	7.5	130
135	10.9	10.5	10.4	9.1	9	8.9	7.6	7.5	7.6	7.5	7.5	7.6	7.3	7.3	7.4	7.2	7.2	7.3	135
140	10.6	10.2	10.2	8.9	8.8	8.7	7.4	7.4	7.4	7.3	7.3	7.4	7.2	7.1	7.2	7.1	7.1	7.2	140
145	10.3	10	9.9	8.7	8.5	8.5	7.2	7.2	7.2	7.2	7.1	7.2	7	7	7	6.9	6.9	7	145
150	10	9.7	9.7	8.5	8.3	8.3	6.9	7	7.1	7	6.9	7	6.8	6.8	6.9	6.8	6.7	6.8	150
155	9.7	9.5	9.4	8.3	8.1	8.1	6.7	6.8	6.9	6.8	6.8	6.9	6.6	6.6	6.7	6.6	6.6	6.7	155
160	9.4	9.2	9.2	8	7.9	8	6.5	6.6	6.7	6.6	6.6	6.7	6.4	6.5	6.6	6.4	6.4	6.5	160
165	9.1	9	9	7.8	7.7	7.8	6.3	6.4	6.5	6.5	6.4	6.5	6.2	6.3	6.4	6.2	6.3	6.4	165
170	8.8	8.8	8.8	7.7	7.5	7.6	6.1	6.2	6.3	6.3	6.3	6.4	6	6.1	6.2	6	6.1	6.2	170
175	8.5	8.5	8.6	7.5	7.4	7.4	5.9	6	6.1	6.1	6.1	6.2	5.8	5.9	6	5.8	5.9	6	175
180	8.2	8.3	8.4	7.3	7.2	7.3	5.6	5.8	5.9	6	6	6.1	5.6	5.7	5.8	5.5	5.7	5.8	180
185	7.9	8.1	8.2	7.1	7.1	7.1	5.4	5.6	5.7	5.8	5.8	5.9	5.4	5.5	5.6	5.3	5.5	5.6	185
190	7.7	7.8	7.9	7	6.9	7	5.2	5.3	5.5	5.7	5.7	5.8	5.2	5.3	5.4	5	5.3	5.4	190
195	7.4	7.5	7.6	6.8	6.7	6.8	4.9	5.1	5.2	5.5	5.6	5.6	5	5.1	5.2	4.7	5	5.2	195
200	7	7.2	7.3	6.6	6.6	6.7	4.7	4.9	5	5.4	5.4	5.5	4.7	4.9	5	4.5	4.7	4.9	200
205	6.4	6.9	7	6.4	6.4	6.5	4.5	4.6	4.8	5.3	5.3	5.4	4.5	4.7	4.8	4.2	4.5	4.7	205
210	6	6.3	6.6	6.1	6.3	6.3	4.3	4.4	4.5	5.1	5.2	5.2	4.3	4.5	4.6	3.9	4.2	4.4	210
215	5.8	5.9	6	5.6	6.1	6.2	4	4.2	4.3	5	5	5.1	4.1	4.3	4.4	3.6	3.9	4.1	215
220	5.6	5.7	5.8	5.1	5.6	5.8	3.8	4	4.1	4.8	4.9	5	3.9	4	4.2	3.3	3.6	3.8	220
225	5.4	5.5	5.5	4.6	5	5.3	3.6	3.8	3.8	4.6	4.7	4.8	3.6	3.8	3.9	3.1	3.3	3.5	225
230	5.1	5.2	5.3	4.1	4.5	4.7	3.3	3.5	3.6	4.2	4.6	4.7	3.4	3.6	3.7	2.8	3.1	3.2	230
235	4.7	5	5	3.7	4	4.2	3.1	3.3	3.4	3.8	4.2	4.4	3.2	3.4	3.5	2.6	2.8	2.9	235
240	4.2	4.5	4.6	3.2	3.6	3.7	2.9	3.1	3.1	3.3	3.7	3.9	3	3.2	3.3	2.3	2.5	2.6	240
245	3.8	4.1	4.1	2.8	3.1	3.2	2.7	2.8	2.9	2.9	3.3	3.4	2.7	3	3		2.3	2.3	245
250	3.4	3.7	3.6	2.4	2.7	2.7	2.5	2.6	2.6	2.5	2.8	2.9	2.3	2.6	2.8				250
255	3.1	3.2			2.3	2.3	2.3	2.4	2.4		2.4	2.5		2.2	2.3				255
260	2.3																		260

t 270_003_12001_00_000 / t 270_003_11001_00_000

Lifting capacities

Forces de levage

TVK/TVNZK



	42 ft + 23 ft			134 ft + 23 ft			147 ft + 23 ft			160 ft + 23 ft			174 ft + 23 ft			187 ft + 23 ft			199 ft + 23 ft					
	66 ft																							
	0°	20°	40°	0°	20°	40°	0°	20°	40°	0°	20°	40°	0°	20°	40°	0°	20°	40°	0°	20°	40°			
13	19.3																					13		
14	19.3																					14		
15	19.3																					15		
16	19.3																					16		
17	19.3																					17		
18	19.3																					18		
19	19.3																					19		
20	19.3																					20		
22	19.4																					22		
24	19.4																					24		
26	19.4																					26		
28	19.4			16.4																		28		
30	19.3			16.4			16															30		
32	19.1			16.4			16			15.2												32		
34	18.8			16.4			16			15.2												34		
36	18.4	14.3		16.4			15.9			15.2				14.2								36		
38	18	14		16.4			15.9			15.1				14.2								38		
40	17.6	13.7		16.3			15.8			15.1				14.2				13				40		
45	16.5	12.9		16.2			15.6			14.9				14.1				13			11.5	45		
50	15.5	12.2		15.9			15.5			14.8				13.9				12.8			11.4	50		
55	14.6	11.5	9.3	15.6	12.1		15.2	12		14.6				13.8				12.7			11.3	55		
60	13.7	10.9	9	15.3	11.7		15	11.6		14.4	11.4			13.6				12.5			11.2	60		
65	12.6	10.4	8.8	14.9	11.3		14.6	11.3		14.2	11.1			13.4	10.8			12.4	10.4		11.1	65		
70	11.5	9.9	8.6	14.4	11	8.8	14.2	10.9	8.7	13.8	10.8			13.2	10.5			12.2	10.1		11	9.6	70	
75	10.5	9.5	8.3	13.9	10.6	8.6	13.8	10.6	8.6	13.4	10.5	8.5		12.9	10.2			12	9.9		10.8	9.5	75	
80	9.7	9.2	8.2	13.4	10.3	8.5	13.4	10.3	8.5	13.1	10.2	8.4		12.5	10	8.3		11.8	9.7		10.7	9.3	80	
85	9	8.9	8	13	10	8.4	12.9	10	8.3	12.7	9.9	8.3		12.2	9.8	8.2		11.5	9.5	8.1	10.6	9.2	85	
90	8.4	8.6	7.9	12.5	9.8	8.3	12.5	9.8	8.2	12.3	9.7	8.2		11.9	9.6	8.1		11.3	9.4	8	10.4	9	7.8	90
95	7.9	8.4	7.8	12.1	9.6	8.1	12.1	9.6	8.1	12	9.5	8.1		11.6	9.4	8		11	9.2	7.9	10.2	8.9	7.7	95
100	7.5	8.2	7.8	11.7	9.4	8	11.7	9.4	8	11.6	9.3	8		11.3	9.2	7.9		10.8	9	7.8	10	8.7	7.7	100
105	7.1	8	7.8	11.3	9.2	7.9	11.4	9.2	7.9	11.3	9.2	7.9		11	9.1	7.8		10.5	8.9	7.7	9.9	8.6	7.6	105
110	6.7	7.9	7.8	10.9	9	7.9	11	9	7.9	10.9	9	7.8		10.7	8.9	7.8		10.3	8.7	7.7	9.7	8.5	7.5	110
115	6.4	7.8	7.8	10.5	8.8	7.8	10.7	8.9	7.8	10.6	8.8	7.8		10.4	8.8	7.7		10.1	8.6	7.6	9.6	8.4	7.5	115
120	6.1	7.7		10	8.7	7.7	10.3	8.7	7.7	10.3	8.7	7.7		10.2	8.6	7.6		9.9	8.5	7.6	9.4	8.3	7.4	120
125	5.8			9.6	8.5	7.7	10	8.6	7.7	10	8.6	7.6		9.9	8.5	7.6		9.7	8.4	7.5	9.3	8.2	7.4	125
130				9.2	8.4	7.6	9.6	8.4	7.6	9.7	8.4	7.6		9.7	8.4	7.5		9.5	8.2	7.5	9.1	8.1	7.3	130
135				8.9	8.3	7.6	9.2	8.3	7.6	9.4	8.3	7.5		9.4	8.3	7.5		9.3	8.1	7.4	9	8	7.3	135
140				8.6	8.1	7.6	8.9	8.2	7.5	9.1	8.2	7.5		9.2	8.2	7.5		9.1	8.1	7.4	8.8	7.9	7.3	140
145				8.3	8	7.5	8.6	8.1	7.5	8.8	8.1	7.5		8.9	8.1	7.4		8.9	8	7.3	8.6	7.8	7.2	145
150				8	7.9	7.5	8.3	8	7.5	8.5	8	7.4		8.7	8	7.4		8.6	7.9	7.3	8.4	7.7	7.2	150
155				7.8	7.8	7.5	8.1	7.9	7.5	8.3	7.9	7.4		8.4	7.9	7.4		8.4	7.8	7.3	8.3	7.6	7.2	155
160				7.5	7.8	7.5	7.8	7.8	7.5	8.1	7.8	7.4		8.2	7.8	7.3		8.2	7.7	7.3	8.1	7.6	7.2	160
165				7.3	7.7	7.5	7.6	7.7	7.5	7.8	7.7	7.4		8	7.7	7.3		8	7.6	7.3	7.9	7.5	7.2	165
170				7.1	7.6	7.5	7.4	7.7	7.5	7.6	7.7	7.4		7.8	7.6	7.3		7.8	7.6	7.3	7.8	7.5	7.2	170
175				6.9	7.6	7.5	7.1	7.6	7.5	7.4	7.6	7.4		7.6	7.6	7.3		7.6	7.5	7.3	7.6	7.4	7.2	175
180				6.7	7.5	7.5	7	7.5	7.5	7.2	7.5	7.4		7.4	7.5	7.3		7.4	7.5	7.3	7.4	7.3	7.2	180
185				6.5	7.5	7.5	6.8	7.5	7.5	7	7.5	7.4		7.2	7.5	7.3		7.3	7.4	7.3	7.3	7.3	7.2	185
190				6.4	7.5	7.5	6.6	7.5	7.5	6.8	7.5	7.4		7	7.4	7.3		7.1	7.4	7.3	7.1	7.3	7.2	190
195				6.2	7.5	7.5	6.5	7.5	7.5	6.7	7.4	7.4		6.9	7.4	7.3		6.9	7.3	7.3	7	7.2	7.2	195
200				6.1	7.4	7.5	6.3	7.4	7.5	6.5	7.4	7.4		6.7	7.4	7.3		6.8	7.3	7.3	6.8	7.2	7.2	200
205				5.9	7.4		6.2	7.4	7.5	6.4	7.4	7.4		6.6	7.3	7.3		6.7	7.3	7.3	6.6	7	7.1	205
210				5.8	7.4		6.1	7.3	7.5	6.3	7.4	7.4		6.4	7.2	7.3		6.3	7.1	7.3	6.3	6.8	7	210
215				5.4			5.9	7.3	7.5	6.1	7.3	7.4		6.3	7	7.2		6.1	6.6	7	5.8	6.5	6.8	215
220							5.8	7.3		6	7.1	7.2		6.2	6.8	6.9		5.9	6.1	6.4	5.4	6.1	6.5	220
225							5.2			5.9	6.6	6.5		5.8	6.4	6.6		5.7	5.9	6	5.2	5.5	6	225
230										5.7	6			5.4	5.9	6		5.3	5.7	5.8	5	5.2	5.4	230
235										4.7	5.5			4.9	5.3	5.4		4.8	5.4	5.5	4.8	5	5.2	235
240										2.8				4.5	4.8	4.7		4.4	4.9	5	4.5	4.8	4.9	240
245														4.1	4.3			4.2	4.4	4.5	4.1	4.6	4.7	245
250														3.9				4	4.1	4.3	3.7	4.2	4.3	250
255														3.4				3.9	4		3.5	3.8	3.8	255
260																		3.9	3.9		3.3	3.5	3.4	260
265																		3.3			3.1	3.2	3.2	265
270																					2.9	3		270
275																					2.5			275

t_270_003_13001_00_000 / t_270_003_14001_00_000

Lifting capacities

Forces de levage

TVK/TVNZK



	213 ft + 23 ft			226 ft + 23 ft			230 ft + 23 ft			237 ft + 23 ft			243 ft + 23 ft			246 ft + 23 ft			
	66 ft																		
	0°	20°	40°	0°	20°	40°	0°	20°	40°	0°	20°	40°	0°	20°	40°	0°	20°*	40°*	
50	9.9			8.2															50
55	9.9			8.2			6.9			6.4			6						55
60	9.8			8.2			6.9			6.4			6			5.8			60
65	9.7			8.2			6.9			6.4			6			5.8			65
70	9.7			8.2			6.9			6.4			6			5.8			70
75	9.6	8.9		8.2			6.9			6.4			6			5.8			75
80	9.5	8.8		8.2	7.9		6.9			6.4			6			5.8			80
85	9.4	8.7		8.2	7.9		6.9	6.9		6.4	6.8		6	6.4		5.8			85
90	9.4	8.5		8.1	7.9		6.9	6.9		6.4	6.8		6	6.4		5.8	6.3		90
95	9.3	8.4	7.5	8.1	7.8		6.9	6.9		6.4	6.7		6	6.4		5.8	6.3		95
100	9.2	8.3	7.5	8	7.8	7.2	6.9	6.9		6.4	6.7		6	6.4		5.8	6.3		100
105	9.1	8.2	7.4	8	7.7	7.2	6.8	6.8	6.7	6.4	6.7	6.5	6	6.4	6.2	5.8	6.3		105
110	9	8.1	7.3	7.9	7.6	7.1	6.7	6.7	6.7	6.4	6.6	6.5	6	6.3	6.2	5.8	6.2	6	110
115	8.9	8	7.3	7.9	7.4	7.1	6.6	6.6	6.6	6.4	6.5	6.5	6	6.2	6.2	5.8	6.2	6	115
120	8.8	7.9	7.3	7.8	7.3	7	6.4	6.4	6.4	6.3	6.4	6.4	6	6.2	6.2	5.8	6.1	6	120
125	8.7	7.8	7.2	7.6	7.2	6.9	6.3	6.3	6.3	6.2	6.2	6.3	6	6	6.1	5.8	6	6	125
130	8.6	7.8	7.2	7.5	7	6.7	6.2	6.2	6.2	6.1	6.1	6.1	5.9	5.9	6	5.8	5.9	6	130
135	8.4	7.7	7.1	7.3	6.9	6.6	6.1	6.1	6	6	6	6	5.8	5.8	5.9	5.7	5.8	5.9	135
140	8.3	7.6	7.1	7.2	6.8	6.5	5.9	5.9	5.9	5.8	5.9	5.9	5.7	5.7	5.8	5.6	5.6	5.7	140
145	8.1	7.5	7.1	7	6.7	6.4	5.8	5.8	5.8	5.7	5.8	5.8	5.5	5.6	5.7	5.5	5.5	5.6	145
150	8	7.5	7.1	6.9	6.5	6.4	5.6	5.7	5.6	5.6	5.6	5.7	5.4	5.5	5.5	5.4	5.4	5.5	150
155	7.8	7.4	7.1	6.7	6.4	6.3	5.5	5.5	5.5	5.5	5.5	5.5	5.3	5.4	5.4	5.2	5.3	5.4	155
160	7.6	7.3	7.1	6.5	6.3	6.2	5.3	5.4	5.4	5.3	5.4	5.4	5.2	5.3	5.3	5.1	5.2	5.3	160
165	7.5	7.2	7.1	6.4	6.2	6.1	5.2	5.3	5.3	5.2	5.2	5.3	5.1	5.1	5.2	5	5.1	5.2	165
170	7.3	7.1	7	6.2	6.1	6	5.1	5.1	5.2	5.1	5.1	5.2	4.9	5	5.1	4.9	5	5.1	170
175	7.1	7	7	6.1	6	5.9	4.9	5	5.1	4.9	5	5.1	4.8	4.9	5	4.8	4.8	5	175
180	6.9	6.8	6.9	5.9	5.9	5.8	4.8	4.9	5	4.8	4.9	5	4.6	4.8	4.9	4.6	4.7	4.9	180
185	6.8	6.7	6.7	5.8	5.7	5.8	4.7	4.8	4.8	4.7	4.7	4.9	4.5	4.6	4.8	4.5	4.6	4.8	185
190	6.6	6.5	6.6	5.6	5.6	5.7	4.5	4.6	4.7	4.6	4.6	4.7	4.3	4.5	4.7	4.3	4.5	4.7	190
195	6.5	6.4	6.5	5.5	5.5	5.5	4.3	4.5	4.6	4.4	4.5	4.6	4.2	4.4	4.6	4.1	4.3	4.5	195
200	6.3	6.2	6.3	5.4	5.3	5.4	4.1	4.4	4.5	4.3	4.4	4.5	4	4.2	4.4	4	4.2	4.4	200
205	6.1	6.1	6.2	5.2	5.2	5.3	3.9	4.2	4.4	4.2	4.3	4.4	3.9	4.1	4.3	3.8	4.1	4.3	205
210	5.9	6	6.1	5.1	5.1	5.2	3.7	4	4.3	4.1	4.2	4.3	3.7	4	4.2	3.5	3.9	4.1	210
215	5.7	5.8	6	5	5	5.1	3.5	3.8	4.1	4	4.1	4.2	3.5	3.8	4	3.3	3.8	4	215
220	5.4	5.7	5.8	4.9	4.9	5	3.3	3.6	3.9	3.9	4	4.1	3.3	3.6	3.8	3	3.5	3.8	220
225	4.9	5.5	5.7	4.8	4.8	4.9	3.1	3.4	3.7	3.8	3.9	4	3.1	3.4	3.7	2.8	3.3	3.6	225
230	4.6	5.2	5.5	4.6	4.7	4.8	2.9	3.2	3.4	3.7	3.8	3.9	2.9	3.2	3.4	2.5	3	3.3	230
235	4.5	4.7	5.1	4.2	4.6	4.7	2.7	3	3.2	3.6	3.7	3.8	2.7	3	3.2	2.3	2.8	3.1	235
240	4.3	4.4	4.6	3.8	4.5	4.6	2.5	2.8	3	3.5	3.6	3.7	2.5	2.8	3		2.5	2.8	240
245	4.2	4.3	4.4	3.5	4	4.4	2.3	2.6	2.8	3.3	3.5	3.6	2.3	2.6	2.8		2.3	2.5	245
250	3.9	4.2	4.3	2.9	3.6	3.9		2.4	2.6	2.9	3.4	3.5		2.4	2.6				250
255	3.5	4	4	2.5	3.2	3.4			2.3	2.6	3.2	3.4		2.3	2.4				255
260	3.2	3.6	3.7		2.7	3					2.8	3.1			2.2				260
265	2.8	3.2	3.3		2.3	2.5					2.4	2.7							265
270	2.5	2.8	2.9									2.3							270
275		2.5	2.4																275

* only possible in TVNZK mode - uniquement possible en cas de fonctionnement de la pointe pliante hydraulique de la flèche télescopique (TVNZK)

t_270_003_13001_00_000 / t_270_003_14001_00_000

Lifting heights

Hauteurs de levage

TVK/TVNZK

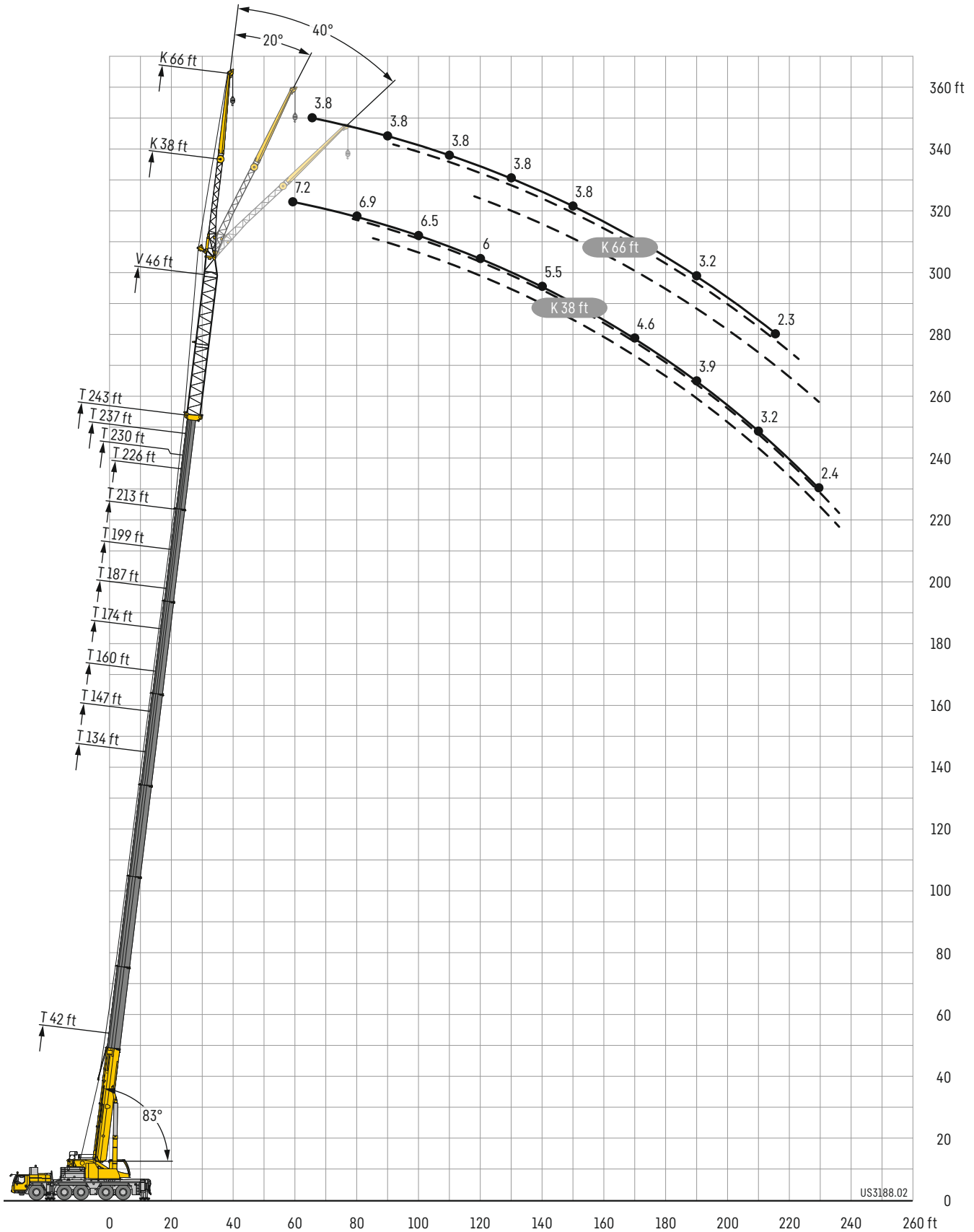

Lifting capacities

Forces de levage

TVK/TVNZK

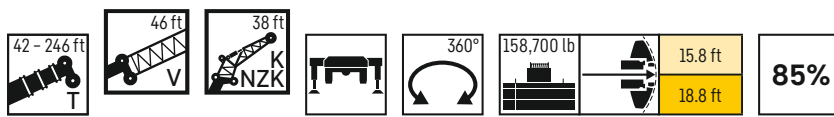

42 ft + 46 ft	134 ft + 46 ft			147 ft + 46 ft			160 ft + 46 ft			174 ft + 46 ft			187 ft + 46 ft			199 ft + 46 ft						
	0°	20°	40°	0°	20°	40°	0°	20°	40°	0°	20°	40°	0°	20°	40°	0°	20°	40°				
13	46.1																		13			
14	46.1																		14			
15	45.9																		15			
16	45.5																		16			
17	44.9																		17			
18	44.1																		18			
19	43.3																		19			
20	42.5																		20			
22	40.9																		22			
24	39.3																		24			
26	37.7	34.3																	26			
28	36.2	33																	28			
30	34.8	31.7		28.5															30			
32	33.4	30.6		28.2			26.4												32			
34	32.1	29.4		27.7			26.1			21.9									34			
36	30.9	28.2	23.9	27.3			25.8			23.8									36			
38	29.6	26.9	23.4	26.9			25.4			23.5			19.8						38			
40	28.3	25.7	23	26.4			25			23.2			19.6		17.1				40			
45	25.1	22.9	21.4	25.2	22.8		24			22.4			19.1		16.8			14.2	45			
50	22.4	20.6	19.4	24.1	21.8		23.1	21		21.6	20		18.7		16.4			14	50			
55	20	18.6	17.6	23	20.8	19	22.1	20.2	18.5	20.9	19.2		18.2	17.1	16.1	15.3		13.8	55			
60	17.9	16.9	16.1	21.9	19.8	18	21.2	19.3	17.8	20.1	18.5	17.2	17.6	16.6	15.7	15		13.5	13.1	60		
65	16.2	15.4	14.8	20.9	18.9	17.1	20.3	18.5	16.9	19.3	17.8	16.5	17.1	16.1	15.3	14.6		13.2	12.8	65		
70	14.7	14.1	13.6	19.9	17.9	16.2	19.5	17.8	16.2	18.6	17.1	15.8	16.6	15.6	14.8	14.9	14.2	13.7	13	12.5	12.2	70
75	13.4	12.9	12.5	19	17	15.5	18.7	16.9	15.4	17.9	16.5	15.2	16.1	15.1	14.4	14.5	13.8	13.3	12.7	12.3	11.9	75
80	12.3	11.9	11.6	18.1	16.1	14.7	17.9	16.1	14.7	17.3	15.9	14.5	15.6	14.6	14	14.2	13.5	13	12.4	12	11.7	80
85	11.3	10.9	10.8	17.2	15.3	14.1	17.2	15.4	14.1	16.6	15.2	13.9	15.1	14.2	13.6	13.8	13.1	12.6	12.2	11.7	11.4	85
90	10.4	10.2	10	16.3	14.6	13.5	16.4	14.7	13.5	16	14.5	13.4	14.6	13.8	13.1	13.4	12.7	12.3	11.9	11.4	11.2	90
95	9.7	9.5	9.5	15.5	13.8	12.8	15.7	14	13	15.4	13.9	12.9	14.2	13.3	12.7	13.1	12.4	12	11.6	11.2	10.9	95
100	9.1	9	9	14.7	13.2	12.3	14.9	13.4	12.4	14.8	13.3	12.4	13.7	12.9	12.2	12.7	12.1	11.7	11.4	10.9	10.7	100
105	8.6	8.5	8.5	14	12.6	11.8	14.3	12.8	11.9	14.2	12.8	12	13.3	12.5	11.8	12.4	11.7	11.3	11.1	10.7	10.4	105
110	8.1	8.1	8.1	13.3	12.1	11.4	13.6	12.3	11.5	13.6	12.3	11.5	12.9	12.1	11.4	12	11.4	11	10.9	10.4	10.2	110
115	7.7	7.7	7.5	12.7	11.5	10.9	13	11.8	11.1	13	11.8	11.1	12.5	11.7	11	11.7	11.1	10.6	10.6	10.2	10	115
120	7.4			12.1	11	10.5	12.4	11.3	10.7	12.5	11.3	10.8	12.1	11.3	10.7	11.4	10.8	10.3	10.4	10	9.8	120
125				11.5	10.6	10.1	11.8	10.8	10.3	11.9	10.9	10.4	11.7	10.9	10.4	11.1	10.5	10	10.2	9.8	9.5	125
130				11	10.2	9.8	11.3	10.4	10	11.4	10.6	10.1	11.3	10.5	10.1	10.8	10.1	9.8	10	9.6	9.3	130
135				10.6	9.8	9.6	10.8	10.1	9.7	11	10.2	9.9	10.9	10.2	9.8	10.5	9.9	9.6	9.8	9.4	9.2	135
140				10.1	9.5	9.3	10.4	9.7	9.4	10.6	9.9	9.6	10.6	9.9	9.6	10.2	9.6	9.3	9.6	9.2	9	140
145				9.7	9.2	9	10.1	9.4	9.2	10.2	9.6	9.4	10.3	9.6	9.4	9.9	9.4	9.2	9.4	9	8.8	145
150				9.4	8.9	8.8	9.7	9.2	8.9	9.9	9.3	9.1	10	9.4	9.1	9.7	9.2	9	9.2	8.8	8.6	150
155				9.1	8.7	8.5	9.4	8.9	8.7	9.6	9.1	8.9	9.7	9.1	8.9	9.4	9	8.8	9	8.6	8.5	155
160				8.8	8.5	8.4	9.1	8.7	8.5	9.3	8.9	8.7	9.4	8.9	8.8	9.2	8.8	8.6	8.8	8.4	8.3	160
165				8.5	8.2	8.2	8.8	8.4	8.3	9	8.6	8.5	9.1	8.7	8.6	9	8.6	8.4	8.6	8.3	8.2	165
170				8.3	8	8	8.6	8.2	8.2	8.8	8.4	8.3	8.9	8.5	8.4	8.8	8.4	8.3	8.3	8.1	8	170
175				8.1	7.8	7.9	8.3	8	8	8.6	8.3	8.2	8.7	8.3	8.2	8.6	8.2	8.1	8	7.9	7.9	175
180				7.8	7.6	7.7	8.1	7.9	7.8	8.4	8.1	8	8.5	8.1	8.1	8.4	8.1	8	7.8	7.7	7.7	180
185				7.6	7.5	7.6	7.9	7.7	7.7	8.2	7.9	7.9	8.3	8	7.9	8.2	7.9	7.8	7.5	7.5	7.6	185
190				7.5	7.3	7.5	7.7	7.5	7.6	8	7.7	7.8	8.1	7.8	7.8	8	7.7	7.7	7.2	7.3	7.4	190
195				7.3	7.2	7.4	7.5	7.4	7.5	7.8	7.6	7.6	7.6	7.7	7.7	7.4	7.6	7.6	7	7.1	7.2	195
200				7.2	7.1		7.4	7.3	7.4	7.6	7.4	7.5	7.2	7.4	7.6	6.8	7.3	7.5	6.7	6.8	6.9	200
205				7			7.2	7.1	7.3	7.5	7.3	7.4	7	7.1	7.2	6.3	6.7	7	6.2	6.6	6.7	205
210				5.2			7.1	7	7.2	7	7.2	7.3	6.6	6.8	6.9	6	6.1	6.3	5.6	6.1	6.4	210
215							6.7	6.9		6.4	6.7	6.8	6.2	6.5	6.6	5.8	5.9	5.9	5.3	5.6	5.8	215
220							4.9			5.9	6.2	6.1	5.6	6	6.1	5.5	5.6	5.7	5	5.2	5.3	220
225										5.4	5.6		5.1	5.4	5.5	5.1	5.4	5.4	4.8	4.9	5	225
230										4.5			4.6	4.9	4.9	4.6	4.9	5	4.6	4.7	4.8	230
235										2.6			4.2	4.4	4.4	4.1	4.4	4.5	4.3	4.5	4.6	235
240													3.8	3.9		3.9	4	4	3.8	4.1	4.2	240
245													3.6			3.8	3.8	3.9	3.4	3.7	3.8	245
250													3.2			3.7	3.7		3.2	3.3	3.3	250
255																3.6			3	3.1	3.1	255
260																3.1			2.8	2.9	2.8	260
265																			2.6	2.6		265

t_270_003_31001_00_000 / t_270_003_32001_00_000

Lifting capacities

Forces de levage

TVK/TVNZK



	213 ft + 46 ft			226 ft + 46 ft			230 ft + 46 ft			237 ft + 46 ft			243 ft + 46 ft			246 ft + 46 ft			
	38 ft																		
	0°	20°	40°	0°	20°	40°	0°	20°	40°	0°	20°	40°	0°	20°	40°	0°	20°*	40°*	
50	11.6																		50
55	11.4			9.4			7.9			7.7									55
60	11.2			9.4			7.8			7.6			7.2			6.9			60
65	11.1	10.9		9.3			7.7			7.5			7.1			6.9			65
70	10.9	10.7		9.2	9		7.6	7.7		7.5			7.1			6.9			70
75	10.8	10.5	10.3	9.1	8.9		7.5	7.5		7.4	7.4		7	7		6.8	6.9		75
80	10.6	10.3	10.2	8.9	8.7	8.5	7.4	7.4		7.3	7.3		6.9	6.9		6.8	6.8		80
85	10.4	10.1	10	8.8	8.6	8.4	7.3	7.3	7.4	7.1	7.1	7.2	6.8	6.8	6.9	6.7	6.7		85
90	10.2	10	9.9	8.6	8.4	8.2	7.2	7.1	7.2	7	7	7.1	6.7	6.7	6.8	6.6	6.6	6.7	90
95	10.1	9.8	9.7	8.5	8.2	8	7	7	7.1	6.9	6.9	6.9	6.6	6.6	6.7	6.5	6.5	6.6	95
100	9.9	9.7	9.6	8.3	8	7.8	6.9	6.9	6.9	6.8	6.7	6.8	6.5	6.5	6.6	6.4	6.4	6.4	100
105	9.8	9.5	9.4	8.2	7.9	7.7	6.7	6.7	6.8	6.6	6.6	6.7	6.4	6.4	6.4	6.3	6.2	6.3	105
110	9.6	9.4	9.3	8	7.7	7.5	6.6	6.6	6.6	6.5	6.5	6.5	6.2	6.2	6.3	6.1	6.1	6.2	110
115	9.3	9.2	9.2	7.8	7.5	7.4	6.5	6.4	6.5	6.4	6.3	6.4	6.1	6.1	6.2	6	6	6.1	115
120	9.1	9	9	7.7	7.4	7.2	6.3	6.3	6.3	6.2	6.2	6.3	6	6	6.1	5.9	5.9	6	120
125	8.9	8.8	8.7	7.5	7.2	7.1	6.1	6.1	6.2	6.1	6.1	6.1	5.9	5.9	5.9	5.8	5.8	5.9	125
130	8.7	8.5	8.5	7.3	7.1	6.9	6	6	6	5.9	5.9	6	5.7	5.8	5.8	5.7	5.7	5.7	130
135	8.4	8.3	8.3	7.1	6.9	6.8	5.8	5.9	5.9	5.8	5.8	5.9	5.6	5.6	5.7	5.5	5.6	5.6	135
140	8.2	8.1	8.1	7	6.8	6.7	5.7	5.7	5.8	5.6	5.7	5.7	5.5	5.5	5.6	5.4	5.4	5.5	140
145	8	7.9	7.9	6.8	6.6	6.5	5.5	5.6	5.6	5.5	5.5	5.6	5.3	5.4	5.4	5.3	5.3	5.4	145
150	7.8	7.7	7.7	6.6	6.5	6.4	5.4	5.4	5.5	5.3	5.4	5.4	5.2	5.2	5.3	5.1	5.2	5.2	150
155	7.6	7.5	7.5	6.4	6.3	6.3	5.2	5.3	5.3	5.2	5.2	5.3	5.1	5.1	5.2	5	5	5.1	155
160	7.4	7.3	7.3	6.3	6.2	6.2	5.1	5.1	5.2	5.1	5.1	5.2	4.9	5	5	4.9	4.9	5	160
165	7.2	7.1	7.1	6.1	6	6	4.9	5	5	4.9	4.9	5	4.8	4.8	4.9	4.8	4.8	4.9	165
170	7	6.9	7	5.9	5.9	5.9	4.8	4.8	4.9	4.8	4.8	4.9	4.6	4.7	4.8	4.6	4.7	4.7	170
175	6.8	6.7	6.8	5.8	5.7	5.8	4.6	4.7	4.7	4.7	4.7	4.8	4.5	4.6	4.7	4.5	4.5	4.6	175
180	6.6	6.6	6.6	5.6	5.6	5.6	4.4	4.5	4.6	4.5	4.5	4.6	4.3	4.4	4.5	4.3	4.4	4.5	180
185	6.5	6.4	6.5	5.5	5.4	5.5	4.3	4.4	4.5	4.4	4.4	4.5	4.1	4.3	4.4	4.1	4.2	4.4	185
190	6.3	6.3	6.3	5.3	5.3	5.3	4.1	4.2	4.3	4.3	4.3	4.4	3.9	4.1	4.2	3.9	4.1	4.2	190
195	6.2	6.1	6.1	5.2	5.2	5.2	3.8	4	4.2	4.2	4.2	4.3	3.7	3.9	4	3.7	3.9	4	195
200	6	6	6	5.1	5	5.1	3.6	3.8	4	4	4.1	4.1	3.5	3.7	3.9	3.5	3.7	3.9	200
205	5.8	5.8	5.9	4.9	4.9	5	3.4	3.6	3.8	3.9	4	4	3.4	3.6	3.7	3.2	3.5	3.7	205
210	5.6	5.6	5.7	4.8	4.8	4.8	3.2	3.4	3.6	3.8	3.8	3.9	3.2	3.4	3.5	3	3.3	3.5	210
215	5.2	5.5	5.5	4.7	4.7	4.7	3	3.2	3.3	3.7	3.7	3.8	3	3.2	3.3	2.7	3	3.2	215
220	4.7	5.1	5.3	4.6	4.6	4.6	2.8	3	3.1	3.6	3.6	3.7	2.8	3	3.1	2.5	2.8	3	220
225	4.4	4.7	4.9	4.4	4.5	4.5	2.6	2.8	2.9	3.5	3.5	3.6	2.6	2.8	2.9	2.2	2.5	2.7	225
230	4.3	4.3	4.4	4	4.3	4.4	2.4	2.6	2.7	3.4	3.4	3.5	2.4	2.6	2.7		2.2	2.4	230
235	4.1	4.2	4.2	3.5	4	4.2		2.3	2.4	3.2	3.3	3.4		2.4	2.5				235
240	3.9	4	4.1	3.1	3.5	3.7			2.2	3	3.2	3.3			2.3				240
245	3.6	3.8	3.9	2.7	3	3.2				2.7	3	3.1							245
250	3.3	3.5	3.6	2.2	2.6	2.8				2.3	2.7	2.9							250
255	2.9	3.2	3.2			2.3					2.3	2.4							255
260	2.5	2.8	2.8																260
265		2.4	2.4																265

* only possible in TVNZK mode - uniquement possible en cas de fonctionnement de la pointe pliante hydraulique de la flèche télescopique (TVNZK)

t_270_003_31001_00_000 / t_270_003_32001_00_000

Lifting capacities

Forces de levage

TVK/TVNZK



	42 ft + 46 ft			134 ft + 46 ft			147 ft + 46 ft			160 ft + 46 ft			174 ft + 46 ft			187 ft + 46 ft			199 ft + 46 ft						
	0°	20°	40°	0°	20°	40°	0°	20°	40°	0°	20°	40°	0°	20°	40°	0°	20°	40°	0°	20°	40°				
16	18																					16			
17	18																						17		
18	18																						18		
19	18																						19		
20	18																						20		
22	18																						22		
24	18.1																						24		
26	18.1																						26		
28	18																						28		
30	17.9																						30		
32	17.9			14.4																			32		
34	17.7			14.4			13.7																34		
36	17.6			14.4			13.7																36		
38	17.4			14.3			13.7			13													38		
40	17.2	13.8		14.3			13.7			12.9													40		
45	16.6	13.1		14.1			13.6			12.9				11.9				10.6					45		
50	15.9	12.5		14			13.4			12.7				11.7				10.5				9.3	50		
55	15.2	11.9		13.8			13.2			12.5				11.5				10.3				9.1	55		
60	14.3	11.3	9.1	13.4	11.3		12.9	11.1		12.2				11.2				10.1				9	60		
65	13.4	10.8	8.9	13	11		12.6	10.8		11.9	10.5			11				10				8.9	65		
70	12.5	10.4	8.7	12.6	10.6		12.2	10.5		11.6	10.3			10.8	9.9			9.8				8.8	70		
75	11.6	10	8.5	12.2	10.4	8.5	11.9	10.2		11.3	10			10.5	9.7			9.6	9.3			8.7	75		
80	10.6	9.6	8.3	11.8	10.1	8.4	11.5	10	8.4	11	9.8	8.3		10.3	9.6			9.5	9.2			8.6	8.4	80	
85	9.8	9.2	8.2	11.4	9.9	8.3	11.2	9.8	8.2	10.7	9.7	8.2		10	9.4	8		9.3	9			8.4	8.2	85	
90	9.2	8.8	8.1	11.1	9.7	8.2	10.8	9.6	8.1	10.4	9.5	8.1		9.8	9.2	7.9		9.1	8.8	7.8		8.3	8.1	90	
95	8.6	8.4	7.9	10.7	9.5	8.1	10.5	9.4	8	10.1	9.3	8		9.6	9.1	7.9		9	8.6	7.7		8.2	7.9	7.5	95
100	8.1	7.9	7.8	10.3	9.3	8	10.2	9.2	8	9.9	9.2	7.9		9.4	8.9	7.8		8.8	8.4	7.6		8	7.8	7.4	100
105	7.6	7.5	7.4	9.9	9	7.9	9.9	9	7.9	9.6	9	7.8		9.2	8.7	7.7		8.6	8.3	7.6		7.9	7.6	7.4	105
110	7.2	7.1	7	9.6	8.8	7.8	9.6	8.8	7.8	9.4	8.8	7.7		9	8.5	7.6		8.5	8.1	7.5		7.8	7.5	7.3	110
115	6.8	6.7	6.7	9.3	8.5	7.8	9.3	8.5	7.7	9.1	8.5	7.7		8.8	8.3	7.6		8.3	7.9	7.4		7.6	7.3	7.1	115
120	6.4	6.3	6.4	9	8.2	7.7	9	8.3	7.6	8.9	8.2	7.6		8.5	8.1	7.5		8.1	7.7	7.3		7.5	7.2	7	120
125	6.1	6	6.1	8.7	8	7.5	8.8	8	7.5	8.7	8	7.5		8.3	7.9	7.4		7.9	7.5	7.2		7.3	7.1	6.9	125
130	5.8	5.8	5.8	8.4	7.7	7.3	8.5	7.8	7.4	8.4	7.8	7.3		8.1	7.6	7.2		7.8	7.4	7		7.2	6.9	6.8	130
135	5.5	5.5	5.6	8.1	7.5	7.1	8.2	7.5	7.2	8.2	7.5	7.1		7.9	7.4	7.1		7.6	7.2	6.9		7	6.8	6.6	135
140	5.2	5.2		7.8	7.2	6.9	8	7.3	7	7.9	7.3	7		7.7	7.2	6.9		7.4	7	6.7		6.9	6.6	6.5	140
145	5	5		7.5	7	6.8	7.7	7.1	6.8	7.7	7.1	6.8		7.5	7	6.7		7.2	6.9	6.6		6.8	6.5	6.3	145
150				7.3	6.8	6.6	7.4	6.9	6.6	7.5	6.9	6.6		7.3	6.9	6.6		7.1	6.7	6.4		6.6	6.4	6.2	150
155				7	6.6	6.4	7.2	6.7	6.5	7.3	6.7	6.5		7.2	6.7	6.4		6.9	6.6	6.3		6.5	6.3	6.1	155
160				6.8	6.4	6.2	7	6.5	6.3	7.1	6.6	6.3		7	6.5	6.3		6.7	6.4	6.2		6.4	6.1	6	160
165				6.6	6.2	6.1	6.8	6.4	6.2	6.8	6.4	6.2		6.8	6.4	6.2		6.6	6.3	6.1		6.3	6	5.9	165
170				6.4	6.1	5.9	6.6	6.2	6	6.7	6.2	6		6.6	6.2	6		6.5	6.1	5.9		6.1	5.9	5.8	170
175				6.2	5.9	5.8	6.3	6	5.9	6.5	6.1	5.9		6.5	6.1	5.9		6.3	6	5.8		6	5.8	5.7	175
180				6	5.7	5.7	6.2	5.9	5.8	6.3	5.9	5.8		6.3	5.9	5.8		6.2	5.8	5.7		5.9	5.7	5.6	180
185				5.8	5.6	5.6	6	5.7	5.7	6.1	5.8	5.7		6.1	5.8	5.7		6	5.7	5.6		5.8	5.6	5.5	185
190				5.7	5.5	5.4	5.8	5.6	5.5	5.9	5.7	5.6		6	5.7	5.6		5.9	5.6	5.5		5.7	5.5	5.4	190
195				5.5	5.3	5.4	5.7	5.4	5.4	5.8	5.5	5.5		5.8	5.5	5.5		5.8	5.5	5.4		5.5	5.3	5.3	195
200				5.4	5.2	5.3	5.5	5.3	5.3	5.6	5.4	5.4		5.7	5.4	5.4		5.6	5.4	5.3		5.4	5.3	5.2	200
205				5.2	5.1	5.2	5.4	5.2	5.3	5.5	5.3	5.3		5.6	5.3	5.3		5.5	5.3	5.2		5.3	5.2	5.1	205
210				5.1	5	5.1	5.3	5.1	5.2	5.4	5.2	5.2		5.4	5.2	5.2		5.4	5.2	5.2		5.2	5.1	5	210
215				5	4.9	5.1	5.1	5	5.1	5.2	5.1	5.1		5.3	5.1	5.1		5.3	5.1	5.1		5.2	5	5	215
220				4.9	4.8	5	5	4.9	5	5.1	5	5.1		5.2	5	5.1		5	5	5		5	4.9	4.9	220
225				4.7	4.7	5	4.9	4.8	5	5	4.9	5		5	4.9	5		4.8	4.9	5		4.6	4.8	4.9	225
230				4.6	4.7		4.8	4.7	5	4.9	4.8	4.9		4.9	4.8	4.9		4.6	4.7	4.9		4.1	4.7	4.8	230
235				4.6			4.7	4.7	5	4.8	4.7	4.9		4.7	4.7	4.9		4.5	4.6	4.8		3.9	4.4	4.7	235
240							4.6	4.6		4.6	4.6	4.9		4.4	4.6	4.8		4.2	4.4	4.6		3.8	4	4.4	240
245							4.3			4.3	4.6	4.7		4.4	4.5	4.6		3.8	4.3	4.4		3.6	3.8	3.9	245
250							2.4			3.9	4.2			3.6	4	4.1		3.4	4	4.2		3.4	3.6	3.7	250
255										3.5	3.8			3.2	3.6	3.6		3.1	3.6	3.7		3.1	3.4	3.6	255
260														2.8	3.2	3.1		2.7	3.2	3.2		2.7	3.2	3.3	260
265														2.5	2.7			2.6	2.7	2.8		2.4	2.9	3	265
270														2.4	2.5			2.6	2.6	2.7			2.5	2.6	270
275														2.3				2.5	2.6						275
280																		2.4	2.5						280
285																		2.2							285

t_270_003_34001_00_000 / t_270_003_33001_00_000

Lifting capacities

Forces de levage

TVK/TVNZK



	213 ft + 46 ft			226 ft + 46 ft			230 ft + 46 ft			237 ft + 46 ft			243 ft + 46 ft			
	66 ft															
	0°	20°	40°	0°	20°	40°	0°	20°	40°*	0°	20°	40°	0°	20°	40°*	
55	7.6															55
60	7.6			5.8			4.7			4.4						60
65	7.6			5.8			4.7			4.4			3.8			65
70	7.6			5.8			4.7			4.4			3.8			70
75	7.6			5.8			4.7			4.4			3.8			75
80	7.5			5.8			4.7			4.4			3.8			80
85	7.4	7.3		5.8			4.7			4.4			3.8			85
90	7.3	7.2		5.8	6.1		4.7	5.3		4.4	5.1		3.8			90
95	7.2	7.1		5.8	6		4.7	5.3		4.4	5.1		3.8	4.7		95
100	7.1	7	6.8	5.8	6		4.7	5.2		4.4	5.1		3.8	4.7		100
105	7	6.9	6.8	5.8	5.9	5.7	4.7	5.1		4.4	5.1		3.8	4.7		105
110	6.9	6.8	6.7	5.8	5.7	5.6	4.7	5.1	5	4.4	5	4.9	3.8	4.7		110
115	6.9	6.7	6.6	5.8	5.6	5.5	4.7	5	5	4.4	4.9	4.9	3.8	4.7	4.6	115
120	6.8	6.6	6.5	5.7	5.5	5.3	4.7	4.9	4.9	4.4	4.8	4.8	3.8	4.6	4.6	120
125	6.6	6.4	6.4	5.6	5.4	5.2	4.7	4.8	4.8	4.4	4.7	4.8	3.8	4.5	4.6	125
130	6.5	6.3	6.2	5.5	5.2	5.1	4.6	4.7	4.7	4.4	4.6	4.7	3.8	4.4	4.5	130
135	6.4	6.2	6.2	5.4	5.1	5	4.6	4.6	4.6	4.4	4.5	4.6	3.8	4.3	4.5	135
140	6.3	6.1	6	5.3	5	4.9	4.5	4.5	4.5	4.3	4.4	4.5	3.8	4.3	4.4	140
145	6.2	6	6	5.2	4.9	4.8	4.4	4.4	4.4	4.3	4.3	4.4	3.8	4.2	4.3	145
150	6.1	5.9	5.9	5.1	4.8	4.7	4.2	4.3	4.3	4.2	4.2	4.3	3.8	4.1	4.2	150
155	6	5.8	5.8	4.9	4.7	4.6	4.1	4.2	4.2	4.1	4.1	4.2	3.8	4	4.1	155
160	5.9	5.7	5.7	4.8	4.6	4.5	4	4.1	4.1	4	4	4.1	3.8	3.9	4	160
165	5.8	5.6	5.6	4.7	4.5	4.4	3.9	4	4	3.9	3.9	4	3.8	3.8	3.9	165
170	5.6	5.5	5.5	4.6	4.4	4.3	3.8	3.9	3.9	3.8	3.8	3.9	3.7	3.7	3.8	170
175	5.5	5.4	5.4	4.5	4.3	4.3	3.7	3.8	3.8	3.7	3.8	3.8	3.5	3.6	3.7	175
180	5.4	5.3	5.3	4.4	4.2	4.2	3.6	3.7	3.7	3.6	3.6	3.7	3.4	3.6	3.6	180
185	5.3	5.2	5.2	4.3	4.1	4.1	3.4	3.5	3.6	3.4	3.5	3.6	3.3	3.4	3.5	185
190	5.1	5.1	5.1	4.2	4	4	3.3	3.4	3.5	3.3	3.4	3.5	3.2	3.3	3.5	190
195	5	5	5	4.1	4	4	3.1	3.3	3.4	3.2	3.3	3.4	3	3.2	3.4	195
200	4.9	4.9	4.9	4	3.9	3.9	2.9	3.2	3.3	3.1	3.2	3.3	2.8	3.1	3.3	200
205	4.8	4.7	4.8	3.9	3.8	3.8	2.8	3	3.2	3	3.1	3.2	2.7	3	3.2	205
210	4.6	4.6	4.7	3.8	3.8	3.8	2.6	2.9	3.1	2.9	3	3.1	2.5	2.8	3.1	210
215	4.5	4.5	4.6	3.7	3.7	3.7	2.4	2.7	2.9	2.8	2.9	3	2.3	2.7	2.9	215
220	4.4	4.4	4.5	3.6	3.6	3.7	2.2	2.6	2.8	2.7	2.8	2.9		2.5	2.8	220
225	4.3	4.3	4.4	3.5	3.5	3.6		2.4	2.6	2.6	2.7	2.8		2.3	2.6	225
230	4.1	4.2	4.3	3.4	3.4	3.5			2.5	2.4	2.6	2.7			2.4	230
235	3.7	4.1	4.2	3.3	3.3	3.4			2.2	2.4	2.5	2.6			2.2	235
240	3.3	4	4.1	3.2	3.3	3.3				2.3	2.4	2.5				240
245	3.1	3.6	4	2.9	3.2	3.3					2.3	2.4				245
250	3	3.2	3.6	2.6	3.1	3.2						2.3				250
255	2.8	2.9	3.1	2.3	2.9	3.1						2.2				255
260	2.7	2.8	2.9		2.6	2.9										260
265	2.5	2.7	2.8			2.5										265
270		2.5	2.6													270
275		2.3	2.4													275

* only possible in TVNZK mode - uniquement possible en cas de fonctionnement de la pointe pliante hydraulique de la flèche télescopique (TVNZK)

t_270_003_34001_00_000 / t_270_003_33001_00_000

Lifting heights

Hauteurs de levage

TVK/TVNZK

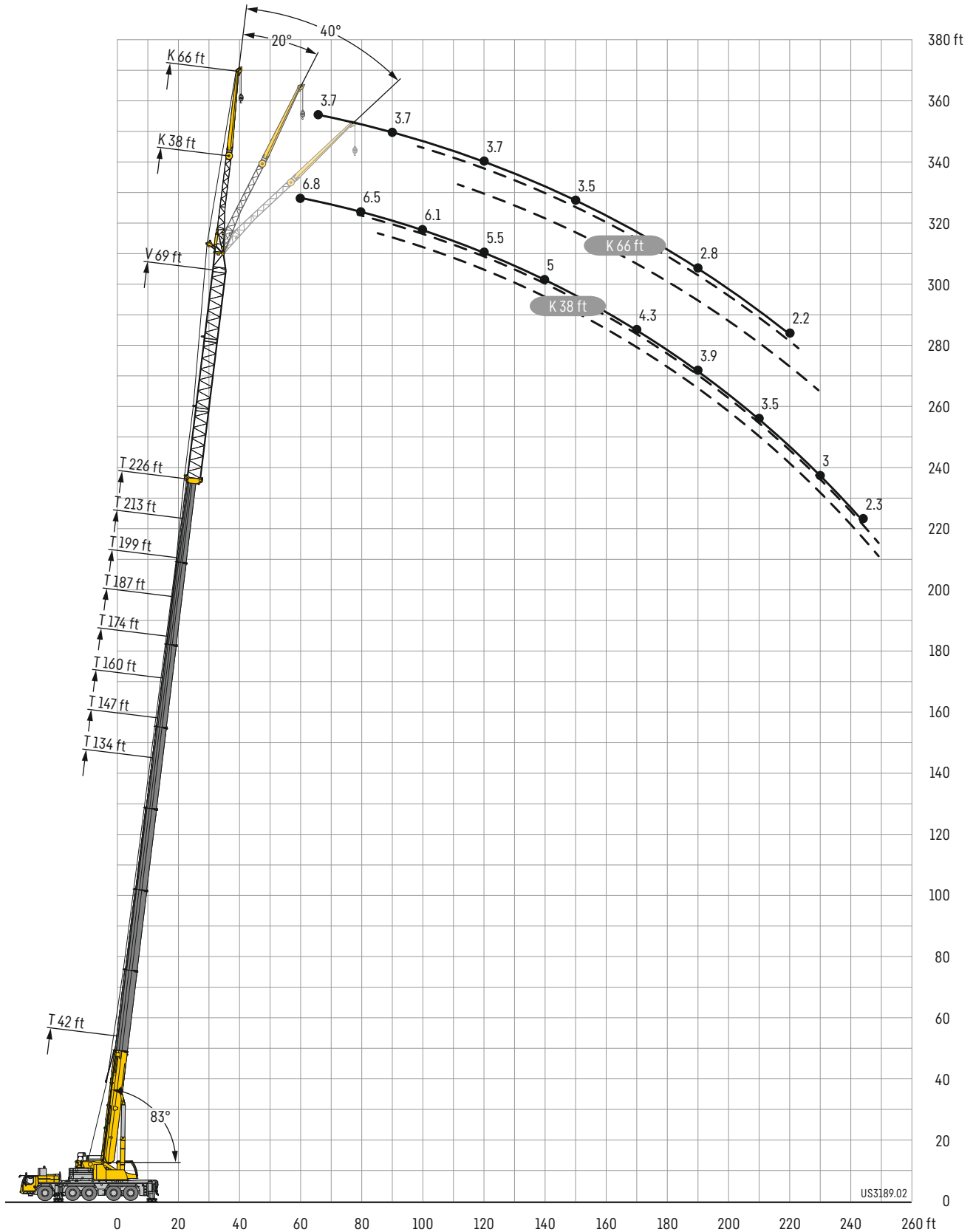

US3189.02

Lifting capacities

Forces de levage

TVK/TVNZK

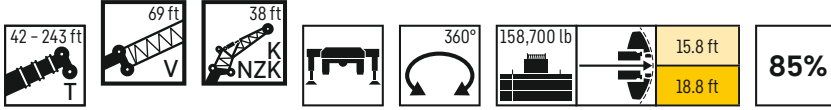

	42 ft + 69 ft			134 ft + 69 ft			147 ft + 69 ft			160 ft + 69 ft			174 ft + 69 ft			187 ft + 69 ft			199 ft + 69 ft			
	38 ft																					
	0°	20°	40°	0°	20°	40°	0°	20°	40°	0°	20°	40°	0°	20°	40°	0°	20°	40°	0°	20°	40°	
17	34.8																					17
18	34.3																					18
19	33.8																					19
20	33.3																					20
22	32.3																					22
24	31.2																					24
26	30.2																					26
28	29.2																					28
30	28.2	26.6																				30
32	27.1	25.7		19.5																		32
34	26.1	24.7					17.9															34
36	25.1	23.8					17.7															36
38	24.1	22.9		18.6			17.5			16.1												38
40	23.1	22	19.7	18.4			17.3			15.9												40
45	20.8	19.7	18.7	17.7	16.7		16.7			15.4			13.8			12						45
50	18.6	17.6	16.9	16.9	16.1		16.1	15.3		14.9			13.5			11.8			9.9			50
55	16.6	15.9	15.3	15.4	15.4		15.5	14.7		14.4	13.8		13.1	12.6		11.5			9.8			55
60	14.9	14.3	13.9	15.5	14.7	13.9	14.9	14.1	13.5	13.9	13.3		12.7	12.2		11.2	10.8		9.6			60
65	13.5	12.9	12.6	14.9	14	13.4	14.3	13.6	12.9	13.4	12.8	12.3	12.3	11.8	11.3	10.9	10.6		9.4	9.3		65
70	12	11.7	11.5	14.2	13.4	12.8	13.7	13	12.4	12.9	12.3	11.8	11.9	11.4	11	10.6	10.3	10	9.3	9.1		70
75	11	10.7	10.5	13.6	12.8	12.3	13.1	12.4	11.9	12.4	11.9	11.4	11.5	11	10.7	10.3	10	9.8	9.1	8.9	8.8	75
80	10	9.8	9.8	13	12.2	11.7	12.6	11.9	11.4	12	11.4	10.9	11.1	10.6	10.3	10	9.7	9.5	8.9	8.7	8.6	80
85	9.2	9.1	9	12.4	11.7	11.1	12.1	11.4	11	11.5	11	10.6	10.7	10.3	10	9.7	9.5	9.3	8.7	8.5	8.5	85
90	8.6	8.5	8.5	11.8	11.1	10.5	11.6	11	10.5	11.1	10.6	10.2	10.3	10	9.7	9.5	9.2	9.1	8.5	8.4	8.3	90
95	8	7.9	7.9	11.3	10.6	10.1	11.1	10.5	10	10.7	10.2	9.8	10	9.7	9.4	9.3	9	8.9	8.4	8.2	8.1	95
100	7.5	7.4	7.5	10.8	10.1	9.7	10.7	10.1	9.6	10.3	9.8	9.5	9.8	9.4	9.2	9.1	8.8	8.7	8.2	8	7.9	100
105	7	7	7	10.3	9.6	9.3	10.3	9.7	9.3	9.9	9.5	9.2	9.5	9.1	8.9	8.8	8.6	8.4	8	7.8	7.8	105
110	6.6	6.5	6.6	9.9	9.2	8.9	9.9	9.3	8.9	9.6	9.2	8.9	9.2	8.9	8.6	8.6	8.4	8.2	7.8	7.7	7.6	110
115	6.2	6.2	6.2	9.4	8.9	8.6	9.5	8.9	8.6	9.3	8.9	8.6	8.9	8.6	8.4	8.4	8.1	8	7.7	7.5	7.4	115
120	5.8	5.8	5.9	9	8.5	8.3	9.1	8.6	8.3	9	8.6	8.3	8.7	8.3	8.1	8.2	7.9	7.8	7.5	7.3	7.2	120
125	5.5	5.5	5.6	8.6	8.2	8	8.8	8.3	8.1	8.7	8.3	8	8.4	8.1	7.9	8	7.7	7.6	7.3	7.1	7.1	125
130	5.2	5.2	5.3	8.3	7.9	7.7	8.4	8	7.8	8.4	8	7.7	8.2	7.8	7.6	7.7	7.5	7.4	7.2	7	6.9	130
135	4.9	5	5	8	7.6	7.4	8.1	7.7	7.5	8.1	7.7	7.5	7.9	7.6	7.4	7.5	7.3	7.2	7	6.8	6.8	135
140	4.7	4.7		7.6	7.3	7.2	7.8	7.4	7.3	7.8	7.5	7.3	7.7	7.4	7.2	7.3	7.1	7	6.8	6.7	6.6	140
145				7.4	7.1	7	7.5	7.2	7	7.6	7.2	7.1	7.5	7.1	7	7.1	6.9	6.8	6.7	6.5	6.5	145
150				7.1	6.8	6.7	7.2	7	6.8	7.3	7	6.9	7.2	6.9	6.8	7	6.7	6.6	6.5	6.4	6.3	150
155				6.8	6.6	6.5	7	6.7	6.6	7.1	6.8	6.7	7	6.7	6.6	6.8	6.6	6.5	6.3	6.2	6.2	155
160				6.6	6.4	6.3	6.8	6.5	6.4	6.8	6.6	6.5	6.8	6.5	6.4	6.6	6.4	6.3	6.2	6.1	6	160
165				6.4	6.2	6.1	6.5	6.3	6.2	6.6	6.4	6.3	6.6	6.4	6.3	6.4	6.2	6.1	6.1	5.9	5.9	165
170				6.1	6	5.9	6.3	6.1	6	6.4	6.2	6.1	6.4	6.2	6.1	6.3	6.1	6	5.9	5.8	5.8	170
175				5.9	5.8	5.7	6.1	5.9	5.9	6.2	6	5.9	6.2	6	5.9	6.1	5.9	5.8	5.8	5.7	5.6	175
180				5.7	5.6	5.6	5.9	5.8	5.7	6	5.9	5.8	6	5.8	5.8	5.9	5.8	5.7	5.7	5.5	5.5	180
185				5.6	5.4	5.4	5.7	5.6	5.6	5.9	5.7	5.7	5.9	5.7	5.7	5.8	5.6	5.6	5.5	5.4	5.4	185
190				5.4	5.3	5.3	5.6	5.4	5.4	5.7	5.5	5.5	5.7	5.5	5.5	5.6	5.5	5.4	5.4	5.3	5.3	190
195				5.2	5.1	5.2	5.4	5.3	5.3	5.5	5.4	5.4	5.5	5.4	5.4	5.5	5.3	5.3	5.3	5.2	5.2	195
200				5	5	5	5.2	5.1	5.1	5.3	5.2	5.2	5.4	5.3	5.2	5.4	5.2	5.2	5.2	5.1	5.1	200
205				4.9	4.8	4.9	5.1	5	5	5.2	5.1	5.1	5.3	5.1	5.1	5.2	5.1	5.1	5	5	5	205
210				4.8	4.7	4.8	4.9	4.9	4.9	5.1	5	5	5.1	5	5	5.1	5	5	5	4.9	4.9	210
215				4.7	4.6	4.7	4.8	4.7	4.8	4.9	4.9	4.9	5	4.9	4.9	4.9	4.9	4.9	4.9	4.7	4.8	215
220				4.5	4.5	4.6	4.7	4.6	4.7	4.8	4.8	4.8	4.8	4.8	4.8	4.6	4.7	4.8	4.4	4.7	4.7	220
225				4.4	4.4		4.6	4.5	4.6	4.7	4.6	4.7	4.7	4.6	4.7	4.4	4.5	4.6	3.9	4.4	4.6	225
230				4.4			4.5	4.4	4.6	4.6	4.5	4.6	4.5	4.5	4.6	4.2	4.3	4.4	3.7	3.9	4.2	230
235							4.4	4.4		4.4	4.4	4.5	4.1	4.4	4.5	4	4.2	4.2	3.5	3.6	3.7	235
240							4.1			4	4.2	4.2	3.7	4	4.1	3.6	3.9	4	3.3	3.4	3.5	240
245										3.6	3.8		3.3	3.5	3.6	3.2	3.5	3.6	3.1	3.2	3.3	245
250										3.2	3.4		2.9	3.1	3.1	2.8	3.1	3.1	2.8	3	3.1	250
255													2.5	2.7	2.7	2.4	2.7	2.7	2.4	2.8	2.8	255
260													2.2	2.3		2.3	2.4	2.4		2.3	2.4	260
265																2.3	2.3	2.3				265
270																2.2	2.2					270

t_270_003_51001_00_000 / t_270_003_52001_00_000

Lifting capacities

Forces de levage

TVK/TVNZK



	213 ft + 69 ft			226 ft + 69 ft			230 ft + 69 ft			237 ft + 69 ft			243 ft + 69 ft			
	0°	20°	40°	0°	20°	40°	0°	20°	40°*	0°	20°	40°	0°	20°	40°*	
55	8.3															55
60	8.2			6.8			5.5									60
65	8.1			6.7			5.5			5.1			4.5			65
70	7.9	7.9		6.7			5.5			5.1			4.5			70
75	7.8	7.8		6.6	6.6		5.5			5.1			4.5			75
80	7.7	7.6	7.6	6.5	6.5		5.5	5.5		5.1	5.4		4.5	5		80
85	7.6	7.5	7.5	6.4	6.4	6.3	5.4	5.4		5.1	5.3		4.5	5		85
90	7.5	7.4	7.4	6.3	6.2	6.2	5.3	5.3	5.3	5.1	5.2	5.2	4.5	4.9		90
95	7.3	7.2	7.2	6.2	6.1	6	5.2	5.2	5.3	5.1	5.1	5.2	4.5	4.9	4.9	95
100	7.2	7.1	7.1	6.1	6	5.9	5.1	5.1	5.2	5	5	5.1	4.5	4.8	4.8	100
105	7.1	7	7	5.9	5.8	5.7	5	5	5.1	4.9	4.9	5	4.5	4.7	4.7	105
110	7	6.9	6.8	5.8	5.7	5.6	4.9	4.9	5	4.8	4.8	4.9	4.5	4.6	4.6	110
115	6.8	6.7	6.7	5.7	5.5	5.5	4.8	4.8	4.9	4.7	4.7	4.8	4.5	4.5	4.6	115
120	6.7	6.6	6.5	5.5	5.4	5.3	4.7	4.7	4.7	4.6	4.6	4.7	4.4	4.4	4.5	120
125	6.6	6.4	6.4	5.4	5.3	5.2	4.5	4.6	4.6	4.5	4.5	4.6	4.3	4.3	4.4	125
130	6.4	6.3	6.3	5.3	5.1	5.1	4.4	4.5	4.5	4.4	4.4	4.5	4.2	4.2	4.3	130
135	6.3	6.2	6.2	5.1	5	5	4.3	4.4	4.4	4.3	4.3	4.4	4.1	4.1	4.2	135
140	6.2	6.1	6	5	4.9	4.8	4.2	4.2	4.3	4.1	4.2	4.3	4	4	4.1	140
145	6.1	5.9	5.9	4.9	4.8	4.7	4.1	4.1	4.2	4	4.1	4.1	3.9	3.9	4	145
150	5.9	5.8	5.8	4.8	4.7	4.6	4	4	4.1	3.9	4	4	3.8	3.8	3.9	150
155	5.8	5.7	5.7	4.6	4.5	4.5	3.9	3.9	4	3.8	3.8	3.9	3.6	3.7	3.8	155
160	5.7	5.6	5.6	4.5	4.4	4.4	3.7	3.8	3.9	3.7	3.7	3.8	3.5	3.6	3.7	160
165	5.6	5.5	5.5	4.4	4.3	4.3	3.6	3.7	3.7	3.5	3.6	3.7	3.4	3.5	3.6	165
170	5.4	5.3	5.4	4.3	4.2	4.2	3.5	3.5	3.6	3.4	3.5	3.6	3.3	3.4	3.5	170
175	5.2	5.2	5.3	4.2	4.1	4.1	3.3	3.4	3.5	3.3	3.4	3.5	3.2	3.3	3.3	175
180	5.1	5.1	5.1	4.1	4	4	3.1	3.3	3.4	3.2	3.2	3.3	3	3.1	3.2	180
185	5	4.9	5	4	3.9	3.9	3	3.1	3.2	3	3.1	3.2	2.9	3	3.1	185
190	4.8	4.8	4.9	3.9	3.8	3.8	2.8	3	3.1	2.9	3	3.1	2.7	2.9	3	190
195	4.7	4.7	4.7	3.8	3.7	3.8	2.6	2.8	2.9	2.8	2.9	3	2.5	2.7	2.9	195
200	4.6	4.5	4.6	3.7	3.6	3.7	2.4	2.6	2.8	2.7	2.8	2.9	2.4	2.6	2.7	200
205	4.4	4.4	4.5	3.6	3.6	3.6	2.3	2.5	2.6	2.6	2.6	2.7		2.4	2.6	205
210	4.3	4.3	4.4	3.5	3.5	3.5		2.3	2.4	2.4	2.5	2.6		2.2	2.4	210
215	4.2	4.2	4.2	3.4	3.4	3.4			2.3	2.3	2.4	2.5				215
220	4	4.1	4.1	3.3	3.3	3.3				2.2	2.3	2.4				220
225	3.9	3.9	4	3.2	3.2	3.2						2.3				225
230	3.5	3.8	3.9	3	3.1	3.1										230
235	3.1	3.5	3.7	2.9	3	3										235
240	2.8	3.1	3.3	2.7	2.9	2.9										240
245	2.6	2.8	2.9	2.3	2.7	2.8										245
250	2.5	2.6	2.6		2.4	2.5										250
255	2.3	2.4	2.5													255
260		2.3	2.3													260

* only possible in TVNZK mode - uniquement possible en cas de fonctionnement de la pointe pliante hydraulique de la flèche télescopique (TVNZK)

t.270_003_51001_00_000 / t.270_003_52001_00_000

Lifting capacities

Forces de levage

TVK/TVNZK



	42 ft + 69 ft			134 ft + 69 ft			147 ft + 69 ft			160 ft + 69 ft			174 ft + 69 ft			
	0°	20°	40°	0°	20°	40°	0°	20°	40°	0°	20°	40°	0°	20°	40°	
20	16.1															20
22	16.1															22
24	16.1															24
26	16.1															26
28	16.1															28
30	16.1															30
32	16.1															32
34	16															34
36	15.9			11.9												36
38	15.7			11.8												38
40	15.4			11.7			11									40
45	14.7	13		11.4			10.8			10						45
50	13.9	12.4		11.1			10.5			9.9			9.1			50
55	13.1	11.9		10.8			10.2			9.7			8.9			55
60	12.2	11.4	8.6	10.4			10			9.4			8.8			60
65	11.4	10.9	8.3	10.1	9.8		9.7	9.4		9.2			8.6			65
70	10.6	10.2	8.1	9.8	9.5		9.5	9.2		9	8.8		8.4			70
75	9.8	9.5	7.9	9.5	9.2		9.2	8.9		8.8	8.5		8.2	8		75
80	9.1	8.9	7.7	9.2	8.9	7.8	9	8.7		8.6	8.3		8	7.8		80
85	8.4	8.3	7.5	9	8.6	7.7	8.7	8.4	7.7	8.4	8.1		7.8	7.6		85
90	7.8	7.7	7.3	8.7	8.3	7.5	8.5	8.1	7.5	8.1	7.9	7.5	7.7	7.4	7.2	90
95	7.3	7.3	7.1	8.4	8.1	7.4	8.2	7.9	7.4	7.9	7.6	7.3	7.5	7.3	7	95
100	6.8	6.8	6.8	8.1	7.8	7.3	8	7.6	7.3	7.7	7.4	7.1	7.3	7.1	6.8	100
105	6.4	6.4	6.4	7.8	7.5	7.1	7.7	7.4	7	7.5	7.2	6.9	7.1	6.9	6.6	105
110	6	6	6	7.6	7.2	6.8	7.5	7.1	6.8	7.3	7	6.7	6.9	6.7	6.4	110
115	5.6	5.6	5.7	7.3	6.9	6.6	7.2	6.9	6.6	7	6.7	6.5	6.7	6.5	6.3	115
120	5.3	5.3	5.4	7	6.6	6.4	7	6.6	6.4	6.8	6.5	6.3	6.5	6.3	6.1	120
125	5	5	5.1	6.8	6.4	6.1	6.7	6.4	6.1	6.6	6.3	6.1	6.3	6.1	5.9	125
130	4.7	4.7	4.8	6.5	6.1	5.9	6.5	6.2	5.9	6.4	6.1	5.9	6.2	5.9	5.8	130
135	4.4	4.4	4.5	6.3	5.9	5.7	6.3	5.9	5.7	6.2	5.9	5.7	6	5.8	5.6	135
140	4.1	4.2	4.3	6	5.7	5.5	6.1	5.7	5.6	6	5.7	5.5	5.8	5.6	5.4	140
145	3.9	4	4	5.8	5.5	5.3	5.9	5.5	5.4	5.8	5.5	5.3	5.6	5.4	5.3	145
150	3.7	3.8	3.8	5.6	5.3	5.2	5.7	5.4	5.2	5.6	5.3	5.2	5.5	5.3	5.1	150
155	3.5	3.5	3.6	5.3	5.1	5	5.5	5.2	5	5.4	5.2	5	5.3	5.1	5	155
160	3.3	3.3	3.4	5.1	4.9	4.8	5.3	5	4.9	5.2	5	4.9	5.1	4.9	4.8	160
165	3.1	3.2		5	4.7	4.7	5.1	4.8	4.7	5.1	4.8	4.7	5	4.8	4.7	165
170	3			4.8	4.6	4.5	4.9	4.7	4.6	4.9	4.7	4.6	4.8	4.7	4.6	170
175				4.6	4.4	4.4	4.7	4.5	4.5	4.8	4.5	4.5	4.7	4.5	4.4	175
180				4.4	4.3	4.2	4.6	4.4	4.3	4.6	4.4	4.3	4.6	4.4	4.3	180
185				4.3	4.1	4.1	4.4	4.2	4.2	4.5	4.3	4.2	4.4	4.3	4.2	185
190				4.1	4	4	4.2	4.1	4.1	4.3	4.2	4.1	4.3	4.1	4.1	190
195				4	3.9	3.9	4.1	4	3.9	4.2	4	4	4.2	4	4	195
200				3.8	3.7	3.8	4	3.8	3.8	4	3.9	3.9	4.1	3.9	3.9	200
205				3.7	3.6	3.6	3.8	3.7	3.7	3.9	3.8	3.8	3.9	3.8	3.8	205
210				3.6	3.5	3.5	3.7	3.6	3.6	3.8	3.7	3.7	3.8	3.7	3.7	210
215				3.5	3.4	3.4	3.6	3.5	3.5	3.7	3.6	3.6	3.7	3.6	3.6	215
220				3.3	3.3	3.3	3.5	3.4	3.4	3.6	3.5	3.5	3.6	3.5	3.5	220
225				3.2	3.2	3.2	3.4	3.3	3.4	3.5	3.4	3.4	3.5	3.4	3.4	225
230				3.1	3.1	3.2	3.3	3.2	3.3	3.4	3.3	3.3	3.4	3.3	3.3	230
235				3	3	3.1	3.2	3.1	3.2	3.3	3.2	3.2	3.3	3.2	3.3	235
240				2.9	2.9	3.1	3.1	3	3.1	3.2	3.1	3.2	3.2	3.1	3.2	240
245				2.9	2.9	3	3	3	3.1	3.1	3	3.1	3.1	3.1	3.1	245
250				2.8	2.8		2.9	2.9	3	3	3	3.1	3	3	3.1	250
255				2.8			2.8	2.8	3	2.9	2.9	3	2.9	2.9	3	255
260				2.4			2.8	2.8		2.8	2.8	2.9	2.6	2.8	2.9	260
265							2.7	2.7		2.6	2.8	2.9	2.3	2.7	2.8	265
270										2.3	2.6	2.5		2.4	2.4	270
275											2.2					275

t.270.003.53001.00.000 / t.270.003.54001.00.000

Lifting capacities

Forces de levage

TVK/TVNZK



	187 ft + 69 ft			199 ft + 69 ft			213 ft + 69 ft			226 ft + 69 ft			
	0°	20°	40°	0°	20°	40°	0°	20°	40°	0°	20°	40°	
20													20
22													22
24													24
26													26
28													28
30													30
32													32
34													34
36													36
38													38
40													40
45													45
50	8.2												50
55	8.1			7									55
60	8			7			5.3						60
65	7.8			6.9			5.3			3.7			65
70	7.7			6.8			5.3			3.7			70
75	7.5			6.7			5.3			3.7			75
80	7.4	7.2		6.6			5.3			3.7			80
85	7.2	7.1		6.4	6.4		5.3			3.7			85
90	7.1	6.9		6.3	6.2		5.3	5.4		3.7			90
95	6.9	6.7	6.5	6.2	6.1		5.3	5.4		3.7	4.6		95
100	6.8	6.6	6.4	6.1	6	5.9	5.3	5.3		3.7	4.5		100
105	6.6	6.4	6.2	6	5.8	5.7	5.2	5.2		3.7	4.4		105
110	6.4	6.2	6.1	5.8	5.7	5.6	5.1	5.1	5	3.7	4.3		110
115	6.3	6.1	5.9	5.7	5.6	5.5	5	5	4.9	3.7	4.2	4.1	115
120	6.1	5.9	5.8	5.6	5.4	5.4	4.9	4.9	4.8	3.7	4.1	4	120
125	6	5.8	5.6	5.4	5.3	5.2	4.8	4.8	4.7	3.7	4	3.9	125
130	5.8	5.6	5.5	5.3	5.2	5.1	4.7	4.6	4.6	3.7	3.8	3.8	130
135	5.6	5.5	5.4	5.2	5.1	5	4.6	4.5	4.5	3.7	3.7	3.7	135
140	5.5	5.3	5.2	5.1	4.9	4.9	4.5	4.5	4.4	3.7	3.6	3.6	140
145	5.3	5.2	5.1	4.9	4.8	4.8	4.4	4.4	4.3	3.6	3.5	3.5	145
150	5.2	5	5	4.8	4.7	4.7	4.3	4.3	4.2	3.5	3.4	3.4	150
155	5	4.9	4.8	4.7	4.6	4.5	4.3	4.2	4.2	3.4	3.3	3.3	155
160	4.9	4.8	4.7	4.6	4.5	4.4	4.2	4.1	4.1	3.3	3.2	3.3	160
165	4.8	4.6	4.6	4.5	4.3	4.3	4.1	4	4	3.2	3.1	3.2	165
170	4.6	4.5	4.4	4.4	4.2	4.2	4	3.9	3.9	3.1	3.1	3.1	170
175	4.5	4.4	4.3	4.2	4.2	4.1	3.9	3.8	3.8	3	3	3	175
180	4.4	4.3	4.2	4.1	4.1	4.1	3.8	3.7	3.8	2.9	2.9	2.9	180
185	4.3	4.2	4.1	4	4	4	3.7	3.6	3.7	2.9	2.8	2.8	185
190	4.2	4	4	3.9	3.9	3.9	3.6	3.6	3.6	2.8	2.7	2.8	190
195	4.1	3.9	3.9	3.8	3.8	3.8	3.6	3.5	3.5	2.7	2.6	2.7	195
200	3.9	3.8	3.8	3.7	3.7	3.7	3.5	3.4	3.5	2.6	2.6	2.6	200
205	3.8	3.7	3.7	3.7	3.6	3.6	3.4	3.4	3.4	2.5	2.5	2.6	205
210	3.7	3.6	3.6	3.6	3.5	3.5	3.3	3.3	3.3	2.4	2.4	2.5	210
215	3.6	3.5	3.5	3.5	3.4	3.5	3.2	3.2	3.3	2.3	2.3	2.4	215
220	3.6	3.5	3.5	3.4	3.4	3.4	3.1	3.2	3.2	2.2	2.3	2.4	220
225	3.5	3.4	3.4	3.3	3.3	3.3	3	3.1	3.2	2.2	2.2	2.3	225
230	3.4	3.3	3.3	3.3	3.2	3.2	2.9	3	3.1			2.2	230
235	3.3	3.2	3.3	3.2	3.1	3.2	2.8	2.9	3				235
240	3.1	3.1	3.2	2.9	3.1	3.1	2.6	2.8	2.9				240
245	3	3.1	3.1	2.6	3	3	2.4	2.7	2.8				245
250	2.9	2.9	3	2.4	2.8	3		2.6	2.7				250
255	2.8	2.9	2.9	2.3	2.6	2.9		2.4	2.6				255
260	2.5	2.8	2.9		2.3	2.5			2.4				260
265		2.6	2.7			2.3							265
270		2.3	2.4										270
275													275

t_270_003_53001_00_000 / t_270_003_54001_00_000

Lifting heights

Hauteurs de levage

TS

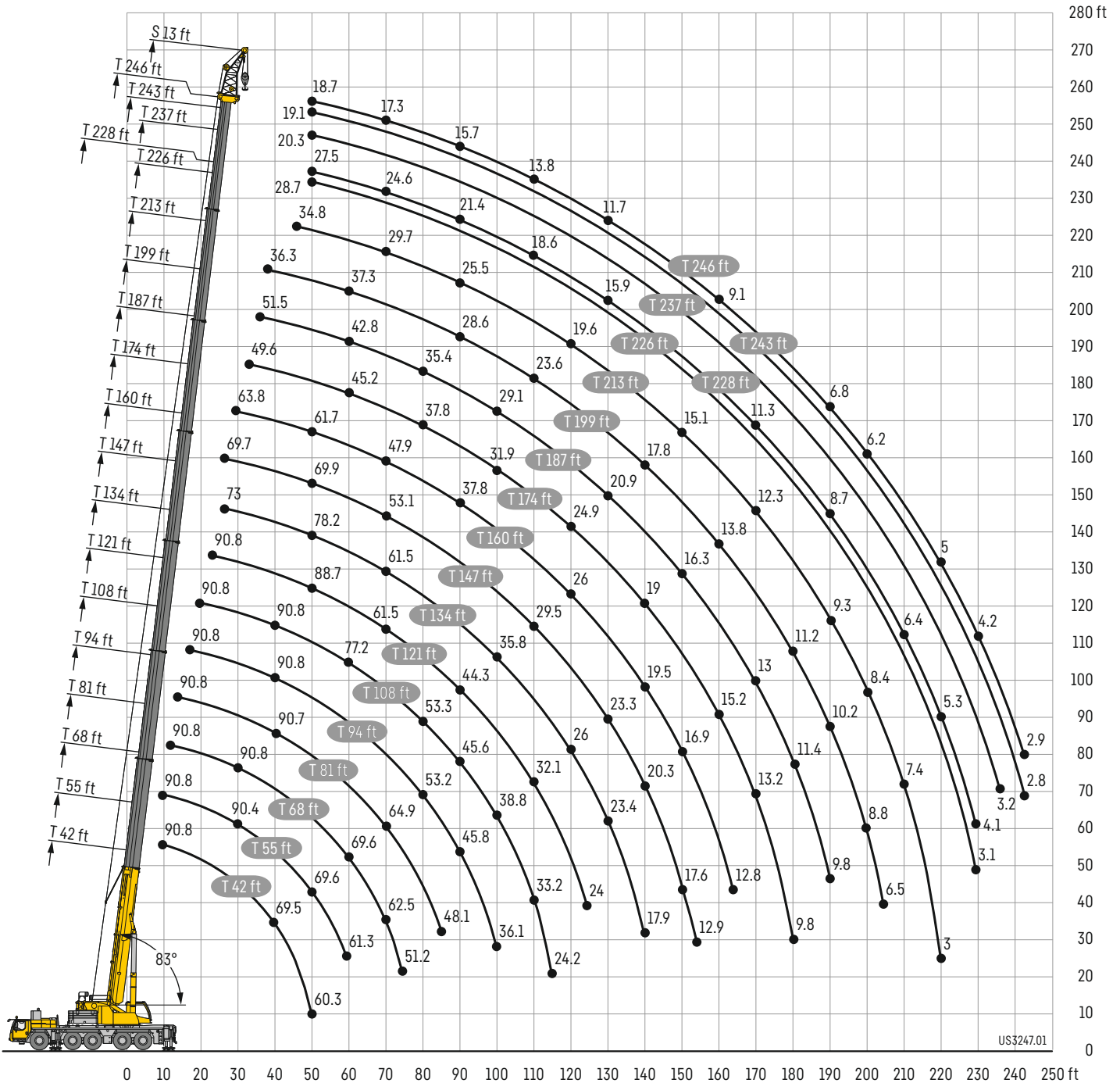

US3247.01

Lifting capacities

Forces de levage

TS

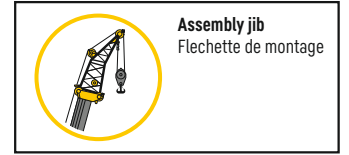
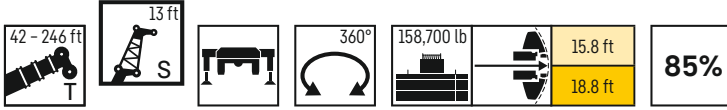

	42 ft	55 ft	68 ft	81 ft	94 ft	108 ft	121 ft	134 ft	147 ft	160 ft	174 ft	187 ft	199 ft	213 ft	226 ft	228 ft	237 ft	243 ft	246 ft				
	13 ft																						
10	90.8	90.8																		10			
11	90.8	90.8	90.8																	11			
12	90.8	90.8	90.8																	12			
13	90.8	90.8	90.8	90.8																13			
14	90.8	90.8	90.8	90.8																14			
15	90.8	90.8	90.8	90.8																15			
16	90.8	90.8	90.8	90.8	90.8															16			
17	90.8	90.8	90.8	90.8	90.8	90.8														17			
18	90.8	90.8	90.8	90.8	90.8	90.8														18			
19	90.8	90.8	90.8	90.8	90.8	90.8	90.8													19			
20	90.8	90.8	90.8	90.8	90.8	90.8	90.8													20			
22	90.8	90.8	90.8	90.8	90.8	90.8	90.8	90.8												22			
24	90.4	90.8	90.8	90.8	90.8	90.8	90.8	73												24			
26	89	90.8	90.8	90.8	90.8	90.8	90.8	90.8	69.7											26			
28	87.4	90.8	90.8	90.8	90.8	90.8	90.8	90.8	90.8											28			
30	84.8	90.4	90.8	90.8	90.8	90.8	90.8	90.8	90.8	63.8										30			
32	81.9	89.3	90.8	90.8	90.8	90.8	90.8	90.8	90.5	77.4	49.6									32			
34	78.5	88.1	90.8	90.8	90.8	90.8	90.8	90.8	89.1	75.9	58.6									34			
36	75.1	86.4	90.4	90.8	90.8	90.8	90.8	90.5	86.4	74.1	57.4	51.5								36			
38	72.1	84.3	89.5	90.8	90.8	90.8	90.8	90.8	89.2	83.7	72.3	56	52.1	36.3						38			
40	69.5	82	88.6	90.7	90.8	90.8	90.8	87.1	81.1	70.5	54.7	51.2	42.9							40			
45	63.7	75.2	84.8	89.2	90.8	90.8	90.8	82.5	75.2	66	51.7	48.8	42.2	34.8						45			
50	60.3	69.6	79.8	86.7	89.6	90.3	88.7	78.2	69.9	61.7	49.3	46.7	40.8	34.1	28.7	27.5	20.3	19.1	18.7	50			
55		65	74.3	82.8	86.5	85.3	81.4	74	65.2	57.8	47.1	44.9	39	33	28	26.9	19.9	18.8	18.4	55			
60		61.3	69.6	77.5	78.4	77.2	74.4	70.3	60.9	54.3	45.2	42.8	37.3	31.9	27.2	26.1	19.4	18.4	18.1	60			
65			65.7	71.4	70.7	69.6	67.5	66.5	56.8	51	43.2	40.7	35.7	30.8	26.4	25.4	19	18	17.7	65			
70			62.5	64.9	64.1	63	61.5	61.5	53.1	47.9	41.3	38.9	34.1	29.7	25.6	24.6	18.5	17.6	17.3	70			
75			51.2	59.2	58.5	57.3	58.3	56.3	49.7	45.2	39.4	37.1	32.7	28.6	24.7	23.7	17.9	17.2	16.9	75			
80				54.1	53.2	53.3	53.1	51.4	46.4	42.6	37.8	35.4	31.3	27.5	23.9	22.9	17.4	16.8	16.5	80			
85				48.1	48.5	49.7	48.4	46.8	43.3	40.2	36.2	33.7	29.9	26.5	23	22.2	17	16.3	16.1	85			
90					45.8	45.6	44.3	42.7	40.5	37.8	34.8	32.1	28.6	25.5	22.2	21.4	16.5	15.9	15.7	90			
95					43	42	40.7	39.1	37.4	35.5	33.3	30.5	27.2	24.5	21.4	20.7	16	15.4	15.2	95			
100					36.1	38.8	37.5	35.8	34.2	33.3	31.9	29.1	25.9	23.5	20.6	20	15.5	14.9	14.8	100			
105						35.9	34.6	33	32	30.6	30.3	27.6	24.7	22.5	19.8	19.3	15	14.4	14.3	105			
110						33.2	32.1	30.4	29.5	29.5	28.7	26.2	23.6	21.5	19.1	18.6	14.6	13.9	13.8	110			
115						24.2	29.8	28.1	27.3	27.6	27	24.9	22.5	20.5	18.4	18	14.1	13.4	13.3	115			
120							27.7	26	26.4	26	24.9	23.6	21.4	19.6	17.7	17.3	13.6	12.8	12.7	120			
125							24	24.1	25	24.3	22.9	22.4	20.5	18.7	17	16.6	13.2	12.3	12.2	125			
130								23.4	23.3	22.6	21.2	20.9	19.6	17.9	16.2	15.9	12.8	11.8	11.7	130			
135								22.8	21.7	21	19.9	19.9	18.7	17.2	15.5	15.2	12.4	11.3	11.3	135			
140								17.9	20.3	19.5	19	18.9	17.8	16.4	14.8	14.6	11.9	10.8	10.8	140			
145									18.9	18.2	18.1	17.6	16.7	15.7	14.2	14	11.6	10.4	10.3	145			
150									17.6	16.9	17.4	16.3	15.9	15.1	13.6	13.4	11.2	10	9.9	150			
155									12.9	16.5	16.3	15.1	14.9	14.5	13	12.8	10.8	9.6	9.5	155			
160										15.9	15.2	14.2	13.8	13.5	12.5	12.3	10.4	9.3	9.1	160			
165										12.8	14.1	13.6	13.1	13	11.9	11.8	10.2	8.9	8.7	165			
170											13.2	13	12.7	12.3	11.4	11.3	9.9	8.6	8.3	170			
175											12.5	12.1	11.8	11.4	10.7	10.7	9.7	8.3	7.9	175			
180												9.8	11.4	11.2	10.5	9.9	10	9.4	8	7.6	180		
185													11.1	10.8	9.8	9.2	9.3	9.2	7.7	7.2	185		
190														9.8	10.2	9.3	8.6	8.7	7.4	6.8	190		
195															9.6	8.9	8	8.1	8.4	7.1	6.5	195	
200																8.8	8.4	7.5	7.6	6.8	6.2	200	
205																	6.5	7.9	6.9	7	6.6	5.9	205
210																							210
215																							215
220																							220
225																							225
230																							230
235																							235
240																							240
245																							245

t_270_005_11001_00_000 / t_270_005_12001_00_000

Lifting heights

Hauteurs de levage

TS

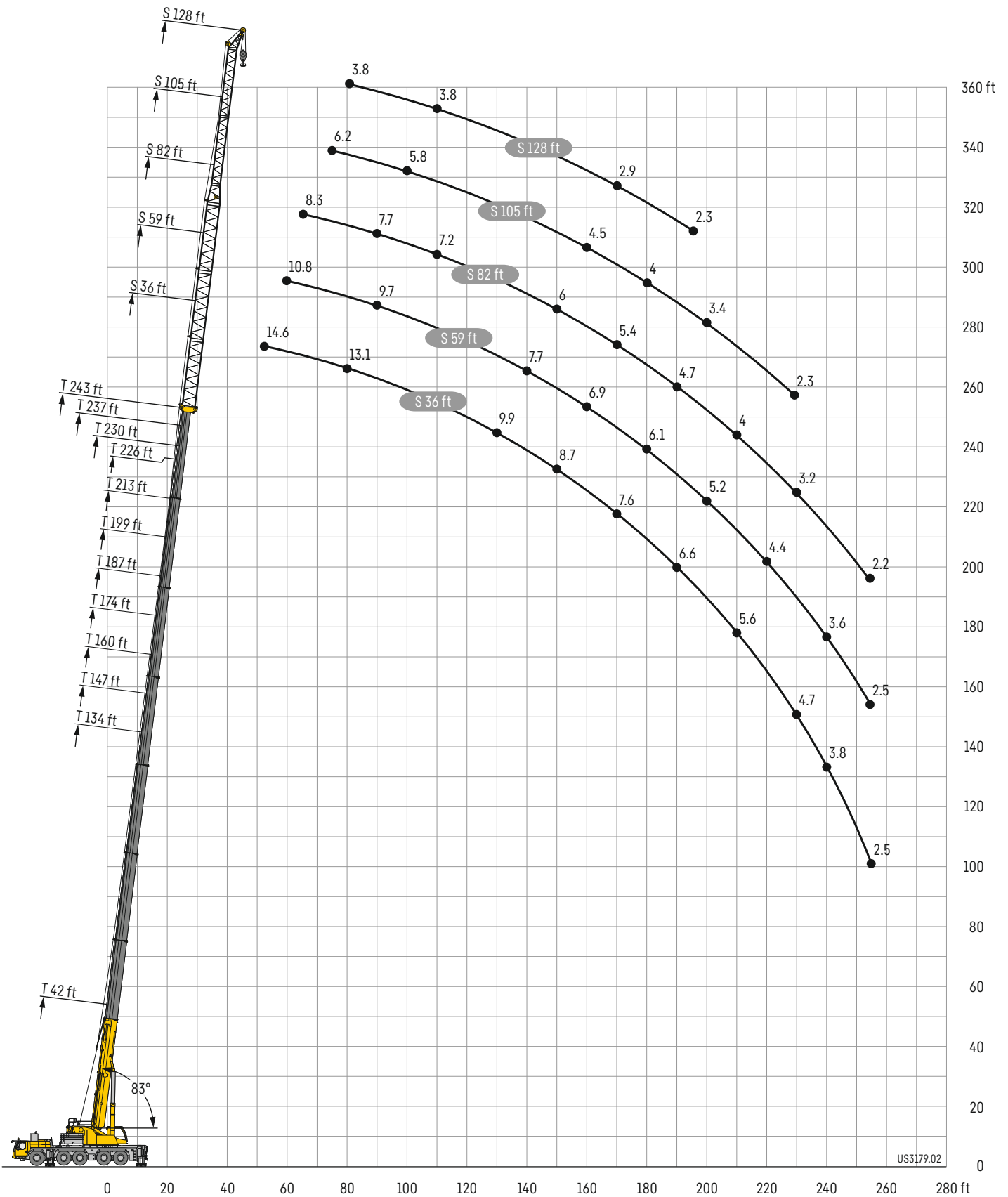

Lifting capacities

Forces de levage

TS

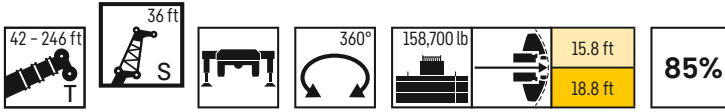

	42 ft	134 ft	147 ft	160 ft	174 ft	187 ft	199 ft	213 ft	226 ft	230 ft	237 ft	243 ft	246 ft	
	36 ft													
11	77.5													11
12	77.5													12
13	76.9													13
14	74													14
15	71.1													15
16	68.4													16
17	65.9													17
18	63.4													18
19	61													19
20	58.8													20
22	54.7													22
24	51													24
26	47.9													26
28	45	61.2												28
30	42.3	59.6	56.9											30
32	40	58	55.7											32
34	37.8	56.4	54.4	51										34
36	35.9	54.9	53.1	50										36
38	34.1	53.5	51.9	49	44.8									38
40	32.5	52.1	50.7	48.1	44.5									40
45	29	48.9	47.9	45.8	43.1	38.4	32.2							45
50	26.1	46.1	45.4	43.7	41.5	37.7	31.7	26.3	20.3	16.1	15.6			50
55	23.7	43.5	43.1	41.7	39.9	36.6	31.1	25.8	20.1	15.8	15.4	14.6	14.2	55
60	21.7	41	41	39.9	38.5	35.1	30.1	25.2	19.6	15.5	15.1	14.3	14	60
65	20	38.6	38.9	38.2	37	33.6	29.1	24.5	19.2	15.1	14.8	14.1	13.8	65
70	18.7	36.4	36.9	36.5	35.5	32.2	28.1	23.7	18.6	14.8	14.5	13.8	13.5	70
75		34.4	35.1	34.9	34.2	30.8	27.2	22.9	18.1	14.4	14.1	13.5	13.2	75
80		32.7	33.3	33.3	32.8	29.5	26.2	22.1	17.6	14	13.7	13.1	12.9	80
85		31	31.8	31.9	31.5	28.3	25.2	21.3	17	13.5	13.4	12.8	12.6	85
90		29.5	30.4	30.5	30.2	27.1	24.2	20.6	16.5	13.1	13	12.5	12.3	90
95		28.1	29	29.3	28.9	25.9	23.1	19.9	16	12.8	12.6	12.1	12	95
100		26.9	27.8	28.2	27.7	24.7	22.1	19.2	15.5	12.4	12.3	11.8	11.7	100
105		25.7	26.7	27.1	26.4	23.5	21.1	18.5	15	12	11.9	11.5	11.3	105
110		24.7	25.6	26.1	25.2	22.5	20.1	17.8	14.5	11.6	11.6	11.2	11	110
115		23.7	24.6	25.2	24	21.4	19.2	17.2	14.1	11.2	11.2	10.8	10.7	115
120		22.8	23.7	24.2	22.9	20.4	18.4	16.6	13.6	10.9	10.9	10.5	10.4	120
125		22	22.9	23.1	21.7	19.5	17.6	15.9	13.2	10.6	10.5	10.2	10.1	125
130		21.2	22.1	21.3	20.6	18.6	16.7	15.3	12.8	10.2	10.2	9.9	9.8	130
135		20.5	21.1	19.7	19.5	17.8	16	14.6	12.4	9.9	9.9	9.6	9.6	135
140		19.8	19.6	18.2	18.2	17	15.3	14	12.1	9.5	9.7	9.4	9.3	140
145		19.2	18.3	17.3	16.8	16.2	14.6	13.3	11.7	9.2	9.5	9.1	9	145
150		18	17	16.4	15.5	15.3	13.9	12.8	11.4	8.8	9.2	8.7	8.7	150
155		16.8	15.9	15.4	14.2	14.2	13.4	12.2	11	8.5	9	8.4	8.4	155
160		14.2	14.8	14.2	13.5	13	12.8	11.7	10.6	8.2	8.8	8.2	8.1	160
165			13.8	13.2	12.9	12	12	11.2	10.3	7.9	8.6	7.9	7.8	165
170			12.5	12.2	12.2	11.2	11.1	10.7	9.9	7.6	8.4	7.6	7.6	170
175			9.1	11.3	11.3	10.6	10.2	10.2	9.6	7.3	8.1	7.4	7.3	175
180				10.5	10.4	10.2	9.5	9.7	9.3	7	7.9	7.1	7	180
185				8.9	9.7	9.7	9.1	9.1	9	6.8	7.7	6.8	6.7	185
190				5.3	9.1	9.2	8.8	8.4	8.7	6.5	7.6	6.6	6.4	190
195					8.4	8.6	8.5	8.1	8.3	6.2	7.4	6.3	6.1	195
200					7.6	8.1	8.2	7.8	7.9	6	7.2	6.1	5.8	200
205						7.9	7.7	7.6	7.3	5.7	7	5.8	5.5	205
210						7.6	7.2	7.3	6.8	5.5	6.8	5.6	5.2	210
215						6.5	6.6	7	6.2	5.2	6.4	5.4	4.9	215
220							6.2	6.5	5.7	5	5.9	5.2	4.6	220
225							6	6	5.2	4.7	5.3	5	4.4	225
230							3.1	5.6	4.7	4.5	4.9	4.7	4.1	230
235								5	4.2	4.3	4.4	4.2	3.8	235
240								3.4	3.7	4.1	3.9	3.8	3.5	240
245									3.3	4	3.5	3.3	3.1	245
250									2.6	3.8	3.1	2.9	2.7	250
255										3.1	2.7	2.5	2.3	255
260											2.3			260

t_270_005_13001_00_000 / t_270_005_14001_00_000

Lifting capacities

Forces de levage

TS

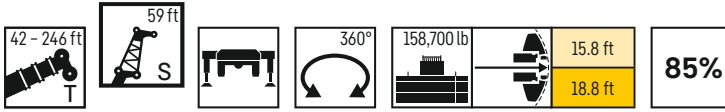

	42 ft	134 ft	147 ft	160 ft	174 ft	187 ft	199 ft	213 ft	226 ft	230 ft	237 ft	243 ft	246 ft	
	59 ft													
14	56.2													14
15	56.2													15
16	56.2													16
17	56													17
18	55.1													18
19	54													19
20	52.8													20
22	50.7													22
24	48.6													24
26	46.6													26
28	44.6													28
30	42.4													30
32	40.2	41.1												32
34	37.9	40.3	38.5											34
36	36	39.5	37.9											36
38	34.2	38.8	37.3	34.9										38
40	32.5	38	36.7	34.4										40
45	29	36.2	35	33.1	30.4	27								45
50	25.9	34.4	33.5	31.8	29.4	26.4	22.3							50
55	23.5	32.7	32	30.6	28.5	25.8	22	18.5	15.3	12	11.6			55
60	21.4	31.2	30.6	29.5	27.6	25.2	21.6	18.3	15.1	11.8	11.5	10.8	10.5	60
65	19.5	29.7	29.4	28.4	26.7	24.5	21.3	18	14.8	11.6	11.3	10.7	10.4	65
70	18	28.3	28.2	27.4	25.9	23.9	20.9	17.7	14.5	11.3	11.1	10.5	10.2	70
75	16.6	26.9	27	26.4	25.1	23.3	20.6	17.2	14.1	11.1	10.9	10.3	10.1	75
80	15.4	25.6	25.9	25.5	24.4	22.7	20.2	16.7	13.8	10.8	10.6	10.1	9.9	80
85	14.3	24.3	24.8	24.6	23.7	22.2	19.8	16.2	13.4	10.5	10.3	9.9	9.7	85
90	13.4	23.2	23.6	23.6	22.9	21.6	19.2	15.6	13	10.2	10.1	9.7	9.5	90
95	12.7	22.2	22.6	22.7	22.2	21.1	18.5	15.1	12.6	10	9.8	9.5	9.3	95
100		21.1	21.7	21.8	21.5	20.6	17.9	14.6	12.2	9.7	9.6	9.3	9.2	100
105		20.2	20.8	21	20.8	20	17.2	14.2	11.8	9.5	9.4	9.1	9	105
110		19.4	19.9	20.2	20	19.3	16.6	13.7	11.4	9.2	9.1	8.9	8.8	110
115		18.6	19.2	19.5	19.4	18.6	16	13.3	11	9	8.9	8.7	8.6	115
120		17.9	18.5	18.8	18.8	17.8	15.5	12.8	10.7	8.8	8.7	8.5	8.4	120
125		17.2	17.8	18.2	18.2	17.1	14.9	12.4	10.3	8.5	8.5	8.3	8.2	125
130		16.6	17.2	17.6	17.6	16.3	14.4	12	10	8.3	8.3	8.1	8	130
135		16	16.6	17	17	15.6	13.8	11.6	9.8	8.1	8.1	7.9	7.8	135
140		15.5	16.1	16.5	16.5	14.9	13.2	11.3	9.5	7.9	7.9	7.7	7.6	140
145		15	15.6	16	16	14.3	12.7	10.9	9.2	7.7	7.7	7.5	7.5	145
150		14.5	15.1	15.5	15.4	13.6	12.1	10.6	9	7.5	7.5	7.3	7.3	150
155		14.1	14.7	15	14.6	13	11.6	10.3	8.8	7.3	7.3	7.1	7.1	155
160		13.7	14.3	14	13.5	12.5	11.1	9.9	8.6	7	7.1	6.9	6.9	160
165		13.3	13.8	13	12.4	11.9	10.6	9.6	8.4	6.8	7	6.7	6.7	165
170		13	13.3	12.4	11.4	11.3	10.2	9.3	8.2	6.6	6.8	6.5	6.5	170
175		12.8	12.4	11.8	10.5	10.3	9.8	9	8	6.3	6.6	6.3	6.3	175
180		12.2	11.6	10.9	10	9.6	9.4	8.7	7.8	6.1	6.5	6.1	6	180
185		8.9	10.7	10.2	9.6	8.9	9	8.4	7.7	5.8	6.3	5.8	5.8	185
190			10	9.5	9.2	8.4	8.5	8.1	7.5	5.6	6.2	5.6	5.6	190
195			8.3	8.9	8.7	8.1	8	7.8	7.3	5.4	6	5.4	5.3	195
200			4.8	8.4	8.2	7.8	7.4	7.6	7.1	5.2	5.9	5.2	5	200
205				7.7	7.6	7.5	7.1	7	6.9	4.9	5.7	5	4.8	205
210				5.6	7	7	6.8	6.5	6.6	4.7	5.6	4.8	4.5	210
215					6.4	6.5	6.6	6.2	6.2	4.5	5.4	4.6	4.2	215
220					5.7	6.1	6.3	6	5.7	4.3	5.3	4.4	3.9	220
225					5.6	5.9	5.8	5.8	5.2	4.1	5.1	4.2	3.7	225
230						5.8	5.3	5.6	4.7	3.9	4.8	4	3.4	230
235						5.6	5	5.3	4.2	3.6	4.4	3.8	3.1	235
240							4.7	4.8	3.8	3.4	3.9	3.6	2.9	240
245							4.5	4.4	3.4	3.2	3.5	3.3	2.6	245
250							3.4	4	3	3	3.1	2.9	2.4	250
255								3.6	2.6	2.8	2.7	2.5		255
260									2.8		2.6	2.3		260
265											2.4			265
270											2.3			270

t 270_005_15001_00_000 / t 270_005_16001_00_000

Lifting capacities

Forces de levage

TS

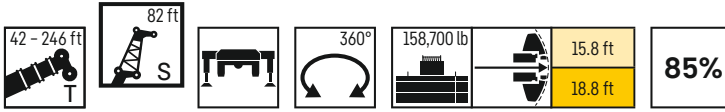

	42 ft	134 ft	147 ft	160 ft	174 ft	187 ft	199 ft	213 ft	226 ft	230 ft	237 ft	243 ft	246 ft	
	82 ft													
18	40													18
19	40													19
20	40													20
22	39.5													22
24	38.2													24
26	36.9													26
28	35.5													28
30	34.3													30
32	33													32
34	31.8													34
36	30.4	29.2												36
38	29	28.6	27.4											38
40	27.6	28.1	26.9											40
45	24.5	26.7	25.8	24.3	22									45
50	21.8	25.4	24.6	23.3	21.3	19.1								50
55	19.8	24.2	23.5	22.4	20.7	18.6	16.2	13.7						55
60	17.9	23	22.5	21.5	20	18.1	15.9	13.5	11.2	9.1				60
65	16.3	21.9	21.5	20.7	19.4	17.7	15.6	13.3	11	8.9	8.7	8.3	8.1	65
70	14.8	20.9	20.6	19.9	18.8	17.2	15.3	13.1	10.8	8.8	8.6	8.2	8	70
75	13.6	19.8	19.7	19.1	18.2	16.7	14.9	12.9	10.6	8.7	8.5	8.1	7.9	75
80	12.5	18.8	18.8	18.4	17.6	16.3	14.6	12.7	10.4	8.5	8.4	8	7.8	80
85	11.6	17.8	18	17.7	17	15.9	14.3	12.5	10.2	8.3	8.2	7.9	7.7	85
90	10.8	16.9	17.1	17	16.5	15.4	14	12.3	10	8.2	8	7.7	7.6	90
95	10	16	16.3	16.3	16	15	13.7	12.1	9.8	8	7.9	7.6	7.5	95
100	9.5	15.3	15.5	15.6	15.5	14.6	13.4	11.7	9.6	7.9	7.8	7.5	7.4	100
105	8.9	14.5	14.9	14.9	15	14.3	13.1	11.3	9.4	7.7	7.6	7.3	7.2	105
110	8.5	13.8	14.2	14.3	14.6	13.9	12.8	10.9	9.1	7.5	7.4	7.2	7.1	110
115	8.1	13.2	13.6	13.7	14.2	13.5	12.5	10.6	8.9	7.4	7.3	7	6.9	115
120		12.7	13	13.2	13.7	13.2	12.3	10.2	8.7	7.2	7.1	6.9	6.8	120
125		12.1	12.5	12.7	13.2	12.8	12	9.9	8.5	7	6.9	6.7	6.6	125
130		11.6	12	12.2	12.8	12.5	11.7	9.6	8.3	6.8	6.8	6.6	6.5	130
135		11.1	11.5	11.7	12.4	12.1	11.4	9.4	8	6.6	6.6	6.4	6.3	135
140		10.7	11.1	11.3	11.9	11.7	11.1	9.1	7.8	6.5	6.4	6.3	6.2	140
145		10.3	10.7	10.9	11.5	11.4	10.8	8.9	7.6	6.3	6.3	6.1	6	145
150		10	10.3	10.5	11.2	11	10.4	8.6	7.4	6.1	6.1	6	5.9	150
155		9.6	10	10.2	10.8	10.7	10.1	8.4	7.2	6	5.9	5.8	5.7	155
160		9.3	9.7	9.9	10.5	10.4	9.8	8.2	7	5.8	5.8	5.7	5.6	160
165		9.1	9.4	9.6	10.2	10.2	9.4	8	6.9	5.6	5.6	5.5	5.5	165
170		8.9	9.2	9.4	9.9	9.9	9.1	7.8	6.7	5.5	5.5	5.4	5.3	170
175		8.6	8.9	9.2	9.7	9.6	8.8	7.6	6.5	5.3	5.4	5.2	5.2	175
180		8.4	8.7	8.9	9.5	9.3	8.5	7.4	6.4	5.2	5.2	5	5	180
185		8.2	8.5	8.7	9.2	9	8.2	7.3	6.2	5	5.1	4.9	4.8	185
190		8.1	8.3	8.5	8.9	8.7	7.9	7.1	6.1	4.8	4.9	4.7	4.7	190
195		7.9	8.2	8.3	8.3	8.2	7.6	6.9	5.9	4.6	4.8	4.5	4.5	195
200		7.8	8	8.2	7.9	7.6	7.4	6.7	5.8	4.4	4.7	4.4	4.3	200
205		7.7	7.9	8	7.6	7	7	6.5	5.6	4.2	4.6	4.2	4	205
210		4.8	7.7	7.5	7.3	6.6	6.5	6.3	5.5	4	4.4	4	3.8	210
215			7.2	7	6.9	6.4	5.9	6	5.4	3.8	4.3	3.8	3.5	215
220			5.2	6.5	6.4	6.1	5.6	5.5	5.2	3.6	4.2	3.6	3.3	220
225				6	5.9	5.8	5.4	5	5.1	3.4	4.1	3.4	3	225
230				4.9	5.4	5.4	5.2	4.9	4.8	3.2	4	3.2	2.8	230
235				2.6	4.9	4.9	5	4.7	4.3	2.9	3.9	3	2.5	235
240					4.4	4.5	4.6	4.5	3.9	2.7	3.8	2.8	2.3	240
245					4.2	4.4	4.2	4.3	3.5	2.5	3.5	2.6		245
250						4.3	3.8	4	3	2.3	3.1	2.4		250
255						4.2	3.6	3.6	2.6		2.7	2.2		255
260						3.4	3.4	3.2	2.3		2.3			260
265							3.3	2.9						265
270							2.8	2.6						270
275								2.2						275

t_270_005.17001_00_000 / t_270_005.18001_00_000

Lifting capacities

Forces de levage

TS

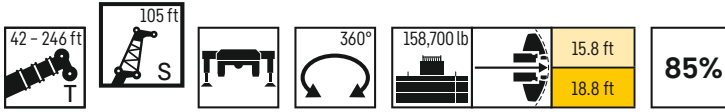

	42 ft	134 ft	147 ft	160 ft	174 ft	187 ft	199 ft	213 ft	226 ft	230 ft	237 ft	243 ft	246 ft	
	105 ft													
22	28.7													22
24	28.7													24
26	28.5													26
28	27.9													28
30	27.1													30
32	26.3													32
34	25.5													34
36	24.7													36
38	24	21.1												38
40	23.1	20.8												40
45	20.7	19.9	19.1	17.8										45
50	18.6	19	18.3	17.2	15.8									50
55	16.7	18.2	17.6	16.6	15.3	13.7								55
60	15.1	17.4	16.9	16	14.8	13.4	11.6	9.8						60
65	13.7	16.6	16.2	15.4	14.4	13	11.3	9.7	7.4	8.3				65
70	12.4	15.9	15.5	14.9	13.9	12.6	11.1	9.6	7.3	8.2	6.8	6.6		70
75	11.3	15.2	14.9	14.3	13.4	12.3	10.9	9.4	7.2	8.1	6.8	6.6	6.2	75
80	10.4	14.5	14.3	13.8	13	11.9	10.6	9.3	7	8	6.7	6.5	6.2	80
85	9.6	13.9	13.7	13.3	12.6	11.6	10.4	9.1	6.9	7.8	6.5	6.4	6.1	85
90	9	13.3	13.2	12.8	12.2	11.3	10.1	9	6.8	7.7	6.4	6.3	6	90
95	8.5	12.6	12.6	12.3	11.8	10.9	9.9	8.9	6.6	7.5	6.3	6.2	5.9	95
100	8	12	12.1	11.9	11.4	10.6	9.7	8.7	6.5	7.4	6.2	6.1	5.8	100
105	7.5	11.4	11.6	11.4	11	10.3	9.5	8.6	6.3	7.2	6	5.9	5.7	105
110	7.1	10.9	11.1	11	10.6	10.1	9.3	8.4	6.2	7.1	5.9	5.8	5.6	110
115	6.7	10.4	10.6	10.5	10.3	9.8	9.1	8.3	6	6.9	5.8	5.7	5.5	115
120	6.4	10	10.2	10.1	10	9.6	8.9	8.2	5.9	6.8	5.7	5.6	5.4	120
125	6	9.5	9.8	9.8	9.7	9.3	8.8	8	5.7	6.6	5.5	5.5	5.3	125
130	5.8	9.1	9.4	9.5	9.4	9.1	8.6	7.9	5.6	6.5	5.4	5.4	5.2	130
135	5.5	8.8	9	9.1	9.1	8.9	8.4	7.7	5.5	6.3	5.3	5.2	5.1	135
140	5.3	8.5	8.7	8.8	8.8	8.6	8.2	7.5	5.3	6.2	5.2	5.1	4.9	140
145		8.2	8.4	8.5	8.6	8.4	8	7.3	5.2	6	5	5	4.8	145
150		7.9	8.2	8.3	8.3	8.2	7.8	7.1	5	5.9	4.9	4.8	4.7	150
155		7.7	7.9	8.1	8.1	8	7.7	6.9	4.9	5.8	4.8	4.7	4.6	155
160		7.4	7.7	7.8	7.8	7.8	7.5	6.8	4.7	5.6	4.6	4.6	4.5	160
165		7.2	7.4	7.6	7.6	7.6	7.4	6.6	4.6	5.5	4.5	4.5	4.4	165
170		7	7.2	7.4	7.4	7.4	7.2	6.4	4.4	5.4	4.4	4.3	4.2	170
175		6.7	7	7.2	7.2	7.2	7	6.2	4.3	5.3	4.2	4.2	4.1	175
180		6.5	6.8	7	7	7	6.9	6.1	4.1	5.1	4.1	4.1	4	180
185		6.4	6.6	6.8	6.9	6.9	6.8	5.9	4	5	3.9	4	3.9	185
190		6.2	6.4	6.6	6.7	6.7	6.6	5.7	3.8	4.9	3.8	3.9	3.7	190
195		6	6.3	6.4	6.5	6.6	6.5	5.6	3.7	4.7	3.6	3.8	3.5	195
200		5.9	6.1	6.3	6.4	6.4	6.3	5.5	3.5	4.6	3.4	3.6	3.4	200
205		5.7	5.9	6.1	6.2	6.3	6.2	5.3	3.3	4.5	3.3	3.5	3.2	205
210		5.6	5.8	6	6.1	6.1	6	5.2	3.1	4.4	3.1	3.4	3	210
215		5.5	5.7	5.8	6	6	5.8	5.1	2.8	4.2	2.9	3.3	2.8	215
220		5.4	5.5	5.7	5.8	5.5	5.5	4.9	2.6	4.1	2.7	3.2	2.6	220
225		5.3	5.4	5.6	5.7	5.2	5	4.8	2.4	4	2.5	3.1	2.5	225
230		5.2	5.3	5.5	5.5	5	4.5	4.5	2.2	3.9	2.3	3	2.3	230
235			5.2	5.3	5.1	4.8	4.4	4.1		3.8		2.9		235
240			4.7	4.9	4.6	4.6	4.2	3.7		3.6		2.7		240
245			2.4	4.5	4.2	4.1	4	3.5		3.4		2.6		245
250				4	3.8	3.7	3.8	3.4		3		2.5		250
255				2.6	3.4	3.3	3.4	3.3		2.6		2.4		255
260					3	3.1	3	3.1		2.2				260
265					2.9	3	2.6	2.8						265
270					2.8	3	2.4	2.5						270
275						2.9	2.2							275
280						2.8								280

t.270.005.19001.00.000 / t.270.005.20001.00.000

Lifting capacities

Forces de levage

TS

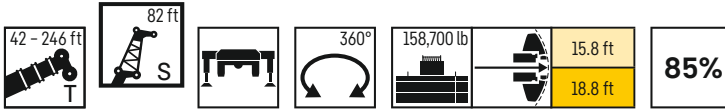

	82 ft													
	42 ft	134 ft	147 ft	160 ft	174 ft	187 ft	199 ft	213 ft	226 ft	230 ft	237 ft	243 ft	246 ft	
26	21.9													26
28	21.9													28
30	21.8													30
32	21.3													32
34	20.8													34
36	20.3													36
38	19.8													38
40	19.3													40
45	17.8	15.4	14.6											45
50	16.3	14.8	14.1	13.2										50
55	14.9	14.1	13.6	12.7	11.6									55
60	13.5	13.5	13	12.2	11.2	10								60
65	12.2	12.9	12.5	11.8	10.8	9.7	8.6							65
70	11.1	12.3	11.9	11.3	10.5	9.5	8.4	7.3						70
75	10.2	11.7	11.4	10.9	10.1	9.3	8.3	7.2	5.4	6.1	4.5	4.5		75
80	9.4	11.2	10.9	10.5	9.8	9	8.1	7.1	5.4	6	4.5	4.5	3.8	80
85	8.6	10.6	10.5	10.1	9.5	8.8	7.9	7	5.3	5.9	4.5	4.5	3.8	85
90	8.1	10.2	10	9.7	9.2	8.6	7.8	6.8	5.2	5.8	4.5	4.5	3.8	90
95	7.5	9.8	9.7	9.4	9	8.4	7.6	6.7	5.1	5.7	4.5	4.5	3.8	95
100	7	9.4	9.3	9.1	8.7	8.2	7.5	6.6	5	5.6	4.5	4.5	3.8	100
105	6.6	9	9	8.8	8.5	8	7.3	6.5	4.8	5.5	4.5	4.4	3.8	105
110	6.2	8.6	8.7	8.5	8.2	7.7	7.1	6.4	4.7	5.4	4.5	4.4	3.8	110
115	5.8	8.2	8.3	8.3	8	7.5	7	6.2	4.6	5.2	4.4	4.3	3.8	115
120	5.5	7.9	8	8	7.7	7.3	6.8	6.1	4.5	5.1	4.3	4.2	3.8	120
125	5.1	7.6	7.7	7.7	7.5	7.1	6.6	6	4.3	5	4.1	4.1	3.8	125
130	4.9	7.2	7.4	7.4	7.2	6.9	6.4	5.8	4.2	4.8	4	4	3.8	130
135	4.6	6.9	7.1	7.1	7	6.7	6.3	5.7	4	4.7	3.9	3.8	3.7	135
140	4.3	6.7	6.9	6.9	6.8	6.5	6.1	5.6	3.9	4.6	3.8	3.7	3.6	140
145	4.1	6.4	6.6	6.7	6.6	6.4	6	5.5	3.8	4.5	3.7	3.6	3.5	145
150	3.9	6.2	6.3	6.4	6.4	6.2	5.8	5.4	3.6	4.3	3.5	3.5	3.3	150
155	3.7	5.9	6.1	6.2	6.2	6	5.7	5.2	3.5	4.2	3.4	3.4	3.2	155
160	3.5	5.7	5.9	6	6	5.8	5.5	5.1	3.4	4.1	3.3	3.2	3.1	160
165		5.5	5.7	5.8	5.8	5.7	5.4	5	3.2	4	3.2	3.1	3	165
170		5.3	5.5	5.6	5.6	5.5	5.3	4.9	3.1	3.9	3	3	2.9	170
175		5.1	5.3	5.4	5.4	5.4	5.1	4.8	3	3.8	2.9	2.9	2.7	175
180		4.9	5.1	5.2	5.3	5.2	5	4.7	2.9	3.7	2.8	2.8	2.6	180
185		4.8	4.9	5.1	5.1	5.1	4.9	4.6	2.7	3.6	2.7	2.6	2.5	185
190		4.6	4.8	4.9	5	4.9	4.8	4.4	2.6	3.5	2.5	2.5	2.4	190
195		4.4	4.6	4.7	4.8	4.8	4.6	4.3	2.5	3.4	2.4	2.4	2.3	195
200		4.3	4.5	4.6	4.7	4.7	4.5	4.2	2.3	3.3	2.3	2.3		200
205		4.1	4.3	4.5	4.5	4.5	4.4	4.1		3.2				205
210		4	4.2	4.3	4.4	4.4	4.3	4		3.1				210
215		3.9	4.1	4.2	4.3	4.3	4.2	3.9		3				215
220		3.8	4	4.1	4.2	4.2	4.1	3.8		2.9				220
225		3.7	3.8	4	4.1	4.1	4.1	3.7		2.8				225
230		3.6	3.7	3.9	3.9	4	4	3.5		2.7				230
235		3.5	3.6	3.8	3.8	3.8	3.8	3.4		2.5				235
240		3.4	3.5	3.7	3.7	3.7	3.4	3.2		2.4				240
245		3.3	3.4	3.6	3.6	3.5	3.1	2.9		2.3				245
250		3.3	3.4	3.5	3.5	3.4	2.9	2.6		2.3				250
255		2.4	3.3	3.4	3.3	3.1	2.7	2.2						255
260			3.2	3.2	2.9	2.8	2.5							260
265				2.9	2.6	2.4	2.3							265
270				2.5	2.2									270

t_270_005_21001_00_000 / t_270_005_22001_00_000

Lifting heights

Hauteurs de levage

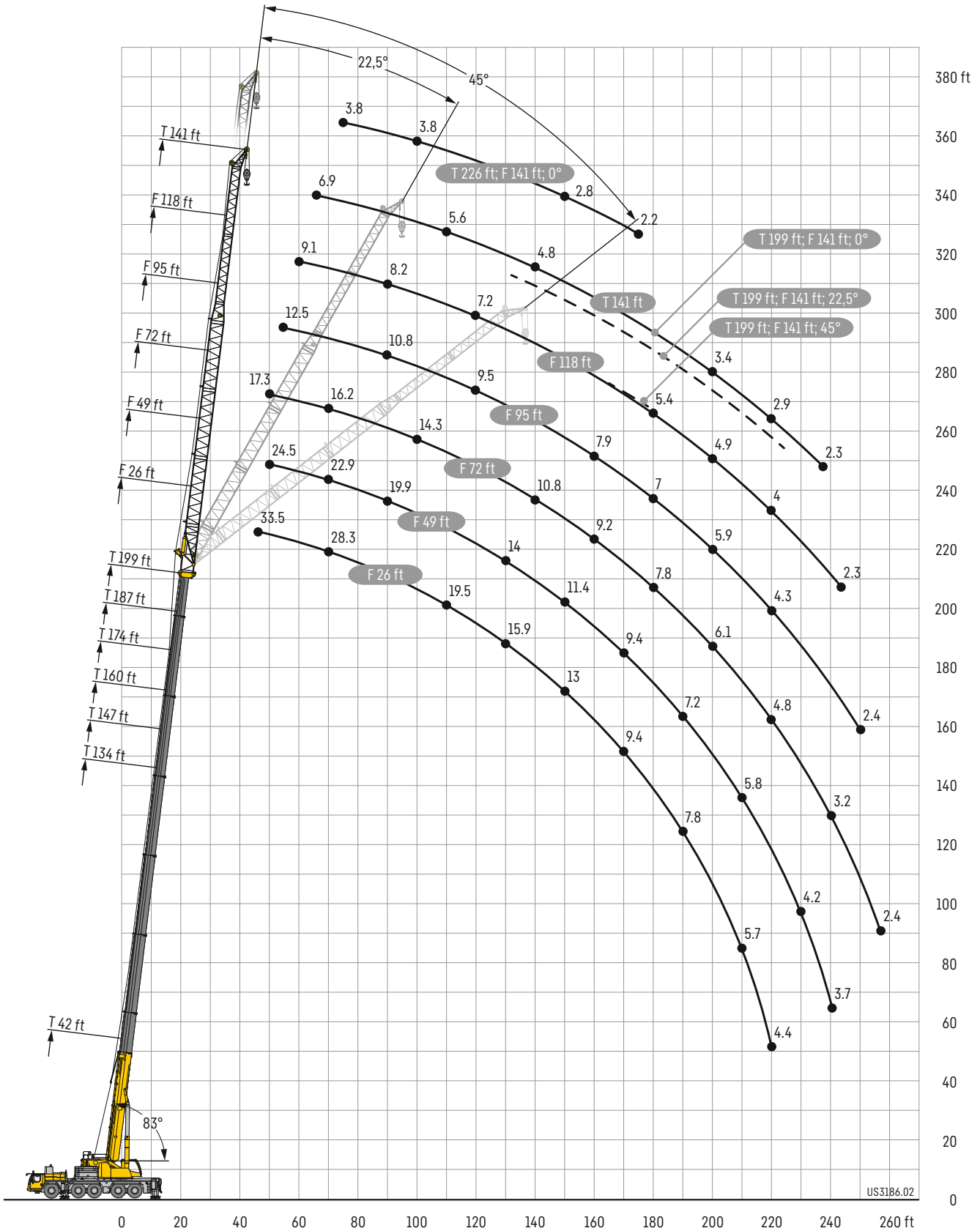

Lifting capacities

Forces de levage

TNZF

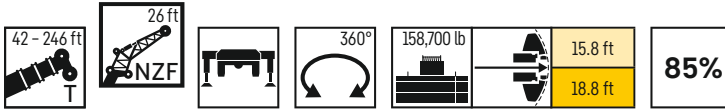

	42 ft			134 ft			147 ft			160 ft			174 ft			187 ft			199 ft							
	0°	22,5°	45°	0°	22,5°	45°	0°	22,5°	45°	0°	22,5°	45°	0°	22,5°	45°	0°	22,5°	45°	0°	22,5°	45°					
10	90.9																					10				
11	90.9																						11			
12	90.9																						12			
13	90.9																						13			
14	90.4																						14			
15	89.1																						15			
16	87.3																						16			
17	85.5																						17			
18	83.7																						18			
19	82.1																						19			
20	80.4	59																					20			
22	77.2	56.2																					22			
24	74.1	53.5																					24			
26	70.7	51.2																					26			
28	67	49	39.5	70.6																			28			
30	63.4	47	38.4	69.4				65.1															30			
32	59.9	45.2	37.3	67.9				64.4															32			
34	56.7	43.5	36.3	66.3				63.5			57.7												34			
36	53.8	41.9	35.5	64.7	47.4			62.7			57.2												36			
38	51.1	40.5	34.6	63.1	46.5			61.7			56.7			50.1									38			
40	48.7	39.1	33.9	61.6	45.5			60.6	46		56.2			49.7				41.3					40			
45	43.5	36.2	32.3	58.1	43.4	35.4		57.5	43.9		54.4	43.2		47.8				40.6			33.5		45			
50	39.3	33.8	31.1	55	41.5	34.4		54.6	42.1	34.9	52.2	41.5	34.6	45.4	40.3			39			32.9		50			
55	35.8	31.8	30.4	52	39.7	33.4		51.9	40.3	33.9	50	40	33.7	43	38.9			37.2			31.9		55			
60	32.9	30.3	30.3	49.1	38.1	32.5		49.5	38.8	33	47.6	38.5	32.9	40.9	37.6	32.4		35.5	35.3	32.1	30.8	29.7		60		
65	30.5	29.8		46.5	36.7	31.7		47.2	37.4	32.2	45	37.2	32.1	38.9	36.4	31.7		33.9	33.7	31.5	29.6	28.7	28.2	65		
70				43.9	35.3	30.9		44.9	36.2	31.5	42.6	36	31.4	37	35.3	31.1		32.3	32.2	30.9	28.3	27.6	27.1	70		
75				41.8	34.2	30.2		42.8	35	30.8	40.2	34.9	30.8	35.2	34.3	30.5		30.8	30.7	30.3	27.1	26.5	26	75		
80				39.8	33	29.6		40.8	33.9	30.2	38.1	33.9	30.2	33.5	33	29.9		29.4	29.4	29.5	25.9	25.4	25	80		
85				37.8	32	29.1		39	32.9	29.7	36	32.9	29.7	31.8	31.5	29.4		28.1	28	28.3	24.8	24.4	24	85		
90				36.2	31.1	28.6		37.2	31.9	29.1	34.1	32	29.2	30.3	29.9	28.8		26.8	26.7	26.9	23.8	23.5	23.1	90		
95				34.5	30.1	28.1		35.3	31	28.7	32.2	31.1	28.7	28.7	28.4	28.2		25.5	25.3	25.5	22.7	22.5	22.3	95		
100				33.1	29.2	27.7		33.3	30.2	28.3	30.3	29.8	28.2	27.3	27	27		24.2	24.1	24.3	21.6	21.5	21.5	100		
105				31.7	28.4	27.4		30.9	29.4	27.9	28.6	28.5	27.6	25.8	25.7	25.7		23	22.9	23.1	20.6	20.5	20.6	105		
110				29.7	27.6	27		28.3	28.5	27.5	27	27.1	27	24.4	24.4	24.5		21.9	21.8	22	19.5	19.5	19.8	110		
115				27.3	26.9	26.6		25.9	27	26.9	25.1	25.7	25.9	23.1	23.2	23.4		20.8	20.7	20.9	18.6	18.6	18.8	115		
120				25.2	25.9	26.2		24.3	24.8	25.3	23.1	24.1	24.6	21.8	22	22.2		19.7	19.7	19.9	17.7	17.7	17.9	120		
125				23.3	24	24.3		22.6	23.1	23.3	21.1	22.2	22.7	20.5	20.9	21.1		18.8	18.8	19	16.8	16.9	17.1	125		
130				21.6	22.2	22.3		20.8	21.6	21.9	19.4	20.3	20.7	19.1	19.7	20		17.8	17.9	18.1	15.9	16	16.3	130		
135				20	20.5	20.5		19.2	19.9	20.1	18.1	18.6	19	17.5	18.4	18.7		16.9	17	17.2	15.1	15.2	15.5	135		
140				18.5	19	18.9		17.7	18.3	18.4	17.1	17.3	17.6	16	16.8	17.2		16	16.2	16.4	14.4	14.5	14.7	140		
145				17.2	17.5	17.3		16.4	16.9	16.9	15.9	16.4	16.7	14.6	15.4	15.7		14.8	15.3	15.6	13.7	13.8	14	145		
150				16	16.2			15.1	15.5	15.5	14.7	15.2	15.4	13.7	14	14.3		13.5	14.3	14.5	13	13.1	13.3	150		
155				12	12.3			13.9	14.3	14.1	13.5	14	14.1	12.9	13.1	13.3		12.3	13	13.2	12.3	12.5	12.7	155		
160								12.9	13.1			12.4	12.8	12.8	12.1	12.4	12.6		11.2	11.8	12	11.3	11.8	12.1	160	
165								10.9	11.5			11.4	11.7	11.6	11.2	11.6	11.7		10.6	10.7	10.9	10.3	10.9	11.1	165	
170								6.8				10.4	10.7	10.5		10.2	10.6	10.6		10.1	10.2	10.3	9.4	9.9	10.1	170
175												9.6	9.8			9.5	9.7	9.7		9.6	9.7	9.8	8.9	9.1	9.2	175
180												7.3	7.5			8.7	9	8.8		9	9.2	9.3	8.5	8.7	8.8	180
185																7.9	8.1	7.9		8.3	8.6	8.5	8.2	8.3	8.4	185
190																7.1	7.3			7.7	7.8	7.8	7.8	7.9	8	190
195																6.8	6.9			7.4	7.5	7.6	7.2	7.5	7.5	195
200																				7.2	7.2		6.5	6.8	6.7	200
205																				6.9	7		5.9	6.2	6	205
210																				4.4			5.7	5.7		210
215																						5.4	5.4			215
220																						4.4	4.4			220

t 270_004_11001_00_00 / t 270_004_12001_00_00

Lifting capacities

Forces de levage

TNZF

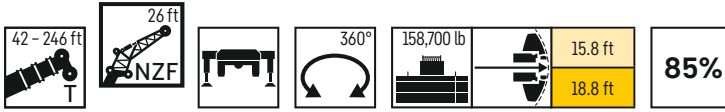







	213 ft			226 ft			230 ft			237 ft			243 ft			246 ft			
	26 ft																		
	0°	22,5°	45°	0°	22,5°	45°	0°	22,5°	45°	0°	22,5°	45°	0°	22,5°	45°	0°	22,5°	45°	
50	27.1			20.6			16.2			15.7			14.7						50
55	26.5			20.3			15.9			15.4			14.5			14.1			55
60	25.8	24.6		19.9			15.5			15.1			14.2			13.9			60
65	24.9	23.7		19.4	18.7		15.1	15		14.8	14.6		13.9	13.9		13.6	13.6		65
70	24.1	22.8	22.2	18.8	18.1	17.9	14.7	14.5	14.7	14.4	14.2		13.6	13.5		13.3	13.3		70
75	23.3	22	21.4	18.2	17.5	17.3	14.2	14.1	14.3	14	13.8	14	13.3	13.2	13.4	13	13	13.2	75
80	22.4	21.2	20.7	17.6	16.9	16.7	13.8	13.6	13.8	13.6	13.4	13.6	12.9	12.8	13	12.7	12.6	12.8	80
85	21.5	20.5	20	17.1	16.3	16.1	13.3	13.2	13.3	13.2	13	13.2	12.6	12.5	12.7	12.3	12.2	12.4	85
90	20.6	19.8	19.4	16.5	15.8	15.6	12.9	12.7	12.9	12.7	12.6	12.7	12.2	12.1	12.3	12	11.9	12.1	90
95	19.9	19.1	18.7	15.9	15.3	15.1	12.5	12.3	12.4	12.3	12.2	12.3	11.8	11.7	11.9	11.7	11.5	11.7	95
100	19.1	18.4	18.2	15.4	14.8	14.6	12	11.9	12	11.9	11.8	11.9	11.5	11.4	11.5	11.3	11.2	11.4	100
105	18.3	17.8	17.6	14.9	14.3	14.2	11.6	11.5	11.6	11.5	11.4	11.5	11.1	11	11.2	11	10.8	11	105
110	17.5	17.1	17	14.3	13.8	13.7	11.2	11.1	11.2	11.2	11	11.1	10.8	10.6	10.8	10.6	10.5	10.7	110
115	16.7	16.5	16.5	13.9	13.4	13.3	10.8	10.7	10.8	10.8	10.6	10.7	10.4	10.3	10.4	10.3	10.2	10.4	115
120	15.9	15.8	15.9	13.4	12.9	12.9	10.4	10.3	10.5	10.4	10.3	10.4	10.1	10.1	10.2	9.9	9.9	10.1	120
125	15.2	15.2	15.4	13	12.5	12.5	9.9	10	10.1	10.1	10	10.1	9.7	9.8	9.9	9.6	9.7	9.8	125
130	14.4	14.6	14.8	12.5	12.2	12.1	9.5	9.6	9.8	9.8	9.7	9.8	9.3	9.4	9.6	9.3	9.4	9.5	130
135	13.7	13.9	14.1	12.1	11.8	11.8	9.1	9.3	9.5	9.5	9.4	9.5	9	9.1	9.3	8.9	9.1	9.3	135
140	13	13.2	13.5	11.6	11.4	11.4	8.8	8.9	9.1	9.2	9.2	9.3	8.6	8.8	9	8.6	8.7	8.9	140
145	12.4	12.5	12.8	11.2	11.1	11.1	8.4	8.6	8.8	9	8.9	9	8.3	8.5	8.6	8.3	8.4	8.6	145
150	11.8	11.9	12.1	10.7	10.7	10.8	8	8.2	8.4	8.7	8.7	8.8	8	8.1	8.3	8	8.1	8.3	150
155	11.2	11.4	11.6	10.3	10.3	10.4	7.7	7.8	8	8.4	8.4	8.6	7.7	7.8	8	7.6	7.8	8	155
160	10.7	10.8	11	9.9	9.9	10.1	7.3	7.5	7.7	8.2	8.2	8.3	7.3	7.5	7.7	7.3	7.5	7.6	160
165	10.2	10.3	10.4	9.5	9.6	9.7	7	7.2	7.3	7.9	8	8.1	7	7.2	7.3	7	7.2	7.3	165
170	9.6	9.9	10	9.1	9.2	9.4	6.7	6.8	7	7.7	7.7	7.8	6.7	6.9	7	6.6	6.8	7	170
175	9	9.3	9.5	8.8	8.9	9	6.4	6.5	6.6	7.5	7.5	7.6	6.5	6.6	6.7	6.3	6.5	6.7	175
180	8.3	8.7	8.8	8.4	8.5	8.6	6.1	6.2	6.3	7.2	7.3	7.4	6.2	6.3	6.5	5.9	6.2	6.3	180
185	7.8	8	8.1	8	8.2	8.3	5.8	5.9	6	7	7.1	7.2	5.9	6.1	6.2	5.6	5.8	6	185
190	7.5	7.6	7.6	7.6	7.8	7.9	5.5	5.6	5.7	6.8	6.9	7	5.6	5.8	5.9	5.2	5.5	5.6	190
195	7.1	7.2	7.3	6.9	7.3	7.4	5.2	5.3	5.4	6.6	6.7	6.8	5.3	5.5	5.6	4.9	5.1	5.2	195
200	6.8	6.9	7	6.2	6.6	6.7	4.9	5	5.1	6.3	6.5	6.6	5.1	5.2	5.3	4.5	4.7	4.9	200
205	6.4	6.6	6.6	5.6	5.9	6	4.6	4.8	4.8	5.8	6.1	6.2	4.8	5	5	4.2	4.4	4.5	205
210	5.8	6.1	6	5	5.3	5.3	4.4	4.5	4.5	5.2	5.6	5.6	4.6	4.7	4.8	3.8	4	4.1	210
215	5.3	5.5	5.4	4.4	4.7	4.6	4.1	4.2	4.3	4.6	5	5	4.3	4.5	4.5	3.5	3.7	3.7	215
220	4.8	4.9	3.1	3.8	4.1	4	3.9	4	4	4.1	4.4	4.4	3.9	4.1	4.2	3.2	3.3	3.4	220
225	4.2	4.4		3.3	3.5	3.4	3.6	3.7	3.7	3.6	3.8	3.8	3.4	3.7	3.7	2.9	3	3	225
230	3.6	3.8		2.8	3	2.8	3.4	3.5	3.4	3.1	3.3	3.2	2.9	3.1	3.1	2.6	2.7	2.7	230
235				2.4	2.5		3.1	3.2		2.6	2.8	2.7	2.4	2.6	2.6		2.4	2.3	235
240							2.9	2.9			2.3								240
245							2.5	2.6											245

t_270_004_11001_00_000 / t_270_004_12001_00_000

Lifting capacities

Forces de levage

TNZF

	42 ft			134 ft			147 ft			160 ft			174 ft			187 ft			199 ft				
	0°	22,5°	45°	0°	22,5°	45°	0°	22,5°	45°	0°	22,5°	45°	0°	22,5°	45°	0°	22,5°	45°	0°	22,5°	45°		
13	60.9																					13	
14	60.9																					14	
15	60.9																					15	
16	60.5																					16	
17	59.5																					17	
18	58.4																					18	
19	57.3																					19	
20	56.3																					20	
22	54.3																					22	
24	52.2																					24	
26	50.1																					26	
28	48.1																					28	
30	45.7			46.2																		30	
32	42.9	30.7		45.5																		32	
34	40.7	29.5		44.6			42.6															34	
36	38.5	28.3		43.8			42			38.6												36	
38	36.4	27.2		42.9			41.3			38.2												38	
40	34.8	26.2		42.1			40.7			37.7			33.9									40	
45	30.9	24		40			38.9			36.4			33			29						45	
50	27.7	22.1	18.5	38	25.5		37.2			35.1			32.1			28.5				24.5		50	
55	25	20.4	17.4	36	24.4		35.6	25.1		33.8	24.7		31.1			27.8				24.1		55	
60	22.7	19	16.5	34.2	23.3		34.1	24.1		32.6	23.8		30.2	23.2		27.2				23.7		60	
65	20.8	17.7	15.8	32.4	22.4	17.4	32.7	23.1	17.9	31.4	23		29.3	22.4		26.6	21.5			23.4		65	
70	19.1	16.7	15.2	30.6	21.5	17	31.3	22.3	17.5	30.4	22.2	17.4	28.5	21.7		26	20.9			22.9	19.8	70	
75	17.6	15.8	14.8	29	20.8	16.6	29.9	21.5	17.1	29.3	21.4	17	27.6	21	16.8	25.4	20.4			22.3	19.3	75	
80	16.4	15	14.7	27.5	20	16.2	28.5	20.8	16.7	28.2	20.7	16.7	26.9	20.4	16.5	24.8	19.8	16.3		21.5	18.8	80	
85	15.3	14.5		26.2	19.3	15.9	27.2	20.2	16.4	27.1	20.1	16.4	26.1	19.8	16.2	24	19.3	16		20.7	18.4	15.6	85
90				25	18.7	15.6	26	19.5	16.1	26.1	19.5	16.1	25.3	19.3	15.9	23.2	18.7	15.7		19.9	17.9	15.4	90
95				23.8	18.1	15.3	24.9	18.9	15.8	25	18.9	15.8	24.5	18.8	15.7	22.2	18.3	15.5		19.1	17.5	15.2	95
100				22.7	17.6	15.1	23.9	18.4	15.6	24	18.4	15.6	23.6	18.3	15.5	21.2	17.9	15.3		18.4	17.1	15	100
105				21.8	17.1	14.8	22.8	17.9	15.4	23.1	17.9	15.4	22.7	17.8	15.3	20.2	17.5	15.1		17.7	16.6	14.8	105
110				20.9	16.6	14.7	22	17.4	15.2	22.3	17.5	15.2	21.8	17.4	15.1	19.3	17.1	14.9		17	16	14.6	110
115				20.1	16.2	14.5	21.2	17	15	21.4	17.1	15	20.8	17	14.9	18.3	16.7	14.8		16.2	15.5	14.5	115
120				19.3	15.8	14.4	20.4	16.6	14.9	20.7	16.7	14.9	19.8	16.6	14.8	17.4	16.4	14.6		15.4	14.9	14.3	120
125				18.6	15.5	14.4	19.6	16.2	14.8	20	16.3	14.7	18.8	16.3	14.7	16.6	16.1	14.5		14.7	14.4	14	125
130				17.9	15.2	14.3	19	15.9	14.7	19.3	16	14.6	17.9	16	14.6	15.8	15.7	14.4		14	13.9	13.7	130
135				17.3	14.9	14.3	18.3	15.6	14.6	18.5	15.7	14.6	17.1	15.7	14.5	15	15.1	14.4		13.3	13.4	13.3	135
140				16.7	14.6	14.3	17.7	15.3	14.6	17.4	15.4	14.5	16.2	15.3	14.4	14.3	14.4	14		12.6	12.9	12.9	140
145				16.1	14.4	14.3	17	15	14.6	16.1	15.2	14.5	15.3	15	14.4	13.6	13.7	13.6		12	12.3	12.5	145
150				15.6	14.2	14.3	16.1	14.8	14.6	14.8	14.9	14.5	14.3	14.7	14.3	12.9	13.1	13.2		11.4	11.7	12	150
155				15.1	14.1	14.3	15	14.6	14.6	13.5	14.5	14.5	13	14.2	14.3	12.3	12.5	12.8		10.8	11.1	11.4	155
160				14.6	14	14.3	13.9	14.3	14.6	12.7	13.5	14	11.9	13.1	13.7	11.6	11.9	12.2		10.3	10.6	10.9	160
165				13.7	13.8		12.8	13.6	13.7	12.1	12.4	12.8	10.8	12	12.6	10.7	11.3	11.6		9.8	10.1	10.4	165
170				12.8	13.2		11.8	12.5	12.5	11.2	11.8	12.1	10	10.9	11.4	9.7	10.8	11		9.4	9.6	9.9	170
175				10.6	11.8		10.9	11.4	11.3	10.3	11	11.2	9.6	9.9	10.3	9	9.9	10.3		9	9.2	9.5	175
180				6.8			10	10.4		9.5	10.1	10.1	9.2	9.4	9.6	8.3	9.1	9.4		8.3	8.9	9.1	180
185							9.2	9.6		8.9	9.3	9.3	8.6	9	9.2	8	8.4	8.6		7.6	8.5	8.7	185
190							6.9	7.4		8.1	8.6		7.9	8.5	8.6	7.6	7.8	8		7.2	7.8	8.1	190
195										7.4	7.8		7.2	7.8	7.8	7.2	7.5	7.6		6.8	7.1	7.4	195
200										6.4	7		6.6	7.1	6	6.6	7.1	7.2		6.5	6.7	6.8	200
205										3.8			6	6.3		6	6.6	6.6		6.2	6.4	6.5	205
210													5.4	5.7		5.7	5.9	6		5.8	6.1	6.2	210
215													5.1			5.5	5.6			5.3	5.8	5.8	215
220													4.2			5.3	5.4			4.8	5.2	5.1	220
225																5.2	5.2			4.4	4.6		225
230																4.5				4.2	4.3		230
235																				4	4		235
240																					3.7		240

t_270_004_13001_00_000 / t_270_004_14001_00_000

Lifting capacities

Forces de levage

TNZF

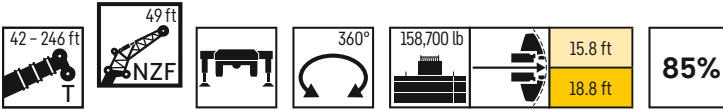

	213 ft			226 ft			230 ft			237 ft			243 ft			246 ft			
	49 ft																		
	0°	22,5°	45°	0°	22,5°	45°	0°	22,5°	45°	0°	22,5°	45°	0°	22,5°	45°	0°	22,5°	45°	
50	19.1																		50
55	19			15.4			12			11.6									55
60	18.7			15.1			11.8			11.5			10.7			10.5			60
65	18.5			14.9			11.6			11.3			10.5			10.3			65
70	18			14.6			11.3			11			10.3			10.1			70
75	17.5	16.2		14.3			11			10.7			10.1			9.9			75
80	16.9	15.6		13.8	12.8		10.6	10.4		10.4	10.3		9.9	9.8		9.7	9.7		80
85	16.4	15.1		13.4	12.4		10.3	10.1		10.1	10		9.7	9.7		9.5	9.5		85
90	15.8	14.5	14	12.9	12	11.4	10	9.9		9.9	9.8		9.5	9.4		9.3	9.3		90
95	15.3	14	13.6	12.5	11.7	11.1	9.8	9.6	9.4	9.6	9.5	9.4	9.3	9.2	9.2	9.1	9.1		95
100	14.7	13.6	13.1	12.1	11.3	10.8	9.5	9.4	9.2	9.4	9.3	9.2	9	9	9	8.9	8.9	9	100
105	14.2	13.1	12.7	11.6	10.9	10.5	9.2	9.1	9	9.1	9	9	8.8	8.8	8.8	8.7	8.7	8.8	105
110	13.7	12.7	12.3	11.2	10.6	10.2	9	8.8	8.8	8.9	8.8	8.8	8.6	8.5	8.6	8.5	8.4	8.6	110
115	13.2	12.3	11.9	10.8	10.2	10	8.7	8.6	8.6	8.7	8.6	8.6	8.4	8.3	8.4	8.3	8.2	8.4	115
120	12.7	11.9	11.6	10.4	9.9	9.8	8.5	8.4	8.4	8.4	8.3	8.3	8.2	8.1	8.2	8.1	8	8.1	120
125	12.3	11.5	11.3	10.1	9.6	9.6	8.2	8.1	8.2	8.2	8.1	8.1	8	7.9	8	7.9	7.8	8	125
130	11.8	11.1	10.9	9.8	9.4	9.3	8	7.9	7.9	8	7.9	7.9	7.7	7.7	7.8	7.7	7.6	7.8	130
135	11.4	10.8	10.6	9.5	9.1	9.1	7.8	7.7	7.7	7.7	7.7	7.7	7.5	7.5	7.6	7.5	7.4	7.6	135
140	11	10.5	10.3	9.2	8.9	8.9	7.5	7.5	7.5	7.5	7.5	7.5	7.3	7.3	7.4	7.2	7.2	7.4	140
145	10.6	10.2	10.1	9	8.7	8.7	7.3	7.3	7.4	7.3	7.3	7.4	7.1	7.1	7.3	7	7.1	7.2	145
150	10.2	9.9	9.9	8.8	8.5	8.5	7	7.1	7.2	7.1	7.1	7.2	6.9	6.9	7.1	6.8	6.9	7	150
155	9.7	9.7	9.6	8.5	8.2	8.3	6.7	6.9	7	6.9	6.9	7	6.6	6.7	6.9	6.5	6.7	6.9	155
160	9.4	9.4	9.4	8.3	8	8.1	6.4	6.6	6.8	6.7	6.7	6.8	6.4	6.5	6.7	6.3	6.5	6.7	160
165	9	9.1	9.3	8.1	7.9	7.9	6.1	6.4	6.6	6.5	6.5	6.7	6.1	6.3	6.5	6	6.3	6.5	165
170	8.7	8.9	9	7.8	7.7	7.7	5.8	6.1	6.3	6.3	6.3	6.5	5.8	6.1	6.3	5.7	6.1	6.3	170
175	8.3	8.5	8.7	7.6	7.5	7.6	5.6	5.8	6.1	6.2	6.2	6.3	5.6	5.8	6.1	5.5	5.8	6.1	175
180	8	8.2	8.4	7.4	7.3	7.4	5.3	5.6	5.8	6	6	6.2	5.3	5.6	5.8	5.2	5.6	5.8	180
185	7.7	7.9	8.1	7.2	7.2	7.3	5.1	5.3	5.5	5.8	5.8	6	5	5.3	5.6	4.8	5.3	5.6	185
190	7.3	7.6	7.8	6.9	7	7.1	4.8	5.1	5.3	5.6	5.7	5.8	4.8	5.1	5.3	4.5	5	5.3	190
195	6.7	7.3	7.5	6.6	6.8	7	4.5	4.8	5	5.4	5.5	5.7	4.5	4.8	5.1	4.2	4.7	5	195
200	6.2	6.9	7.1	6.3	6.6	6.7	4.2	4.5	4.7	5.2	5.3	5.5	4.3	4.6	4.8	3.8	4.4	4.7	200
205	5.9	6.2	6.5	5.8	6.3	6.5	4	4.3	4.5	5.1	5.2	5.3	4	4.4	4.6	3.5	4	4.3	205
210	5.6	5.8	5.9	5.2	6	6.2	3.7	4	4.2	4.9	5	5.2	3.8	4.1	4.3	3.2	3.7	3.9	210
215	5.4	5.6	5.6	4.7	5.4	5.7	3.4	3.7	3.9	4.7	4.9	5	3.5	3.8	4	2.9	3.3	3.6	215
220	5.1	5.3	5.4	4.1	4.8	5	3.1	3.4	3.6	4.2	4.7	4.8	3.2	3.6	3.7	2.6	3	3.2	220
225	4.6	5	5.1	3.6	4.2	4.4	2.9	3.2	3.2	3.7	4.4	4.6	3	3.3	3.4	2.3	2.7	2.9	225
230	4.1	4.6	4.5	3.1	3.7	3.7	2.6	2.9	2.9	3.2	3.9	4	2.8	3.1	3.2		2.4	2.5	230
235	3.7	4		2.6	3.1	3.1	2.4	2.6	2.6	2.8	3.3	3.5	2.5	2.8	2.9				235
240	3.2	3.5			2.6	2.6		2.4	2.3	2.3	2.8	2.9		2.6	2.6				240
245	2.8	3									2.3	2.3			2.2				245
250	2.3	2.5																	250

t 270_004_13001_00_000 / t 270_004_14001_00_000

Lifting capacities

Forces de levage

TNZF

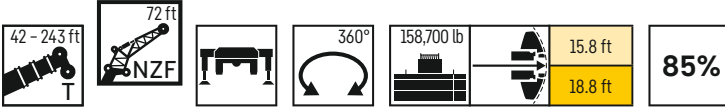

	42 ft			134 ft			147 ft			160 ft			174 ft			187 ft			199 ft				
	72 ft									0°	22,5°	45°	0°	22,5°	45°	0°	22,5°	45°	0°	22,5°	45°		
	0°	22,5°	45°	0°	22,5°	45°	0°	22,5°	45°														0°
17	43																					17	
18	43																						18
19	43																						19
20	42.7																						20
22	41.6																						22
24	40.3																						24
26	39																						26
28	37.7																						28
30	36.3																						30
32	35.1																						32
34	33.7			32.5																			34
36	32.1			31.9																			36
38	30.4			31.3			29.9																38
40	28.8			30.8			29.4			27.2													40
45	25.5	19.1		29.3			28.1			26.3			23.9										45
50	22.8	17.4		27.8			26.9			25.3			23.1			20.3				17.3			50
55	20.5	16		26.4			25.7			24.3			22.4			19.9				17			55
60	18.5	14.7		25.1			24.5			23.4			21.7			19.4				16.8			60
65	16.7	13.6	11.3	23.9	15.8		23.5	15.7		22.5			20.9			19				16.5			65
70	15.3	12.6	10.7	22.8	15.1		22.4	15		21.6	14.9		20.3			18.5				16.2			70
75	14	11.7	10.1	21.6	14.4		21.5	14.4		20.8	14.3		19.6	14.5		18				15.8			75
80	12.9	11	9.6	20.4	13.8	10.4	20.5	13.8		20	13.7		18.9	14		17.6	13.8			15.5			80
85	11.9	10.3	9.3	19.4	13.3	10.1	19.5	13.3	10.1	19.2	13.2		18.3	13.6		17.1	13.4			15.2	12.6		85
90	11	9.8	9	18.3	12.8	9.9	18.6	12.8	9.9	18.4	12.8	9.8	17.7	13.1		16.7	12.9			14.9	12.3		90
95	10.2	9.3	8.7	17.4	12.3	9.7	17.8	12.4	9.7	17.7	12.3	9.6	17.1	12.7	10	16.3	12.6	9.9		14.6	11.9		95
100	9.6	8.9	8.6	16.6	11.8	9.5	16.9	12	9.5	16.9	11.9	9.5	16.5	12.3	9.9	15.8	12.2	9.8		14.3	11.6		100
105	9.1	8.6	8.6	15.8	11.4	9.3	16.2	11.6	9.3	16.2	11.5	9.3	16	11.9	9.7	15.4	11.8	9.6		13.9	11.3	9.4	105
110	8.7	8.5		15	11	9.2	15.5	11.2	9.2	15.5	11.2	9.2	15.5	11.6	9.6	15	11.5	9.5		13.5	11	9.3	110
115				14.4	10.7	9	14.8	10.8	9	14.9	10.8	9	15	11.3	9.4	14.6	11.2	9.4		13	10.7	9.2	115
120				13.8	10.4	8.9	14.1	10.5	8.9	14.4	10.5	8.9	14.5	11	9.3	14.3	10.9	9.3		12.6	10.5	9.1	120
125				13.2	10.1	8.8	13.6	10.2	8.8	13.8	10.2	8.8	14	10.7	9.2	13.9	10.7	9.2		12.1	10.3	9	125
130				12.6	9.8	8.7	13	10	8.7	13.2	10	8.7	13.5	10.4	9.1	13.5	10.4	9.1		11.7	10.1	8.9	130
135				12.1	9.6	8.6	12.5	9.7	8.6	12.8	9.8	8.6	13	10.2	9	12.9	10.2	9		11.2	9.9	8.9	135
140				11.6	9.4	8.5	12.1	9.5	8.6	12.3	9.6	8.5	12.4	10	8.9	12.4	10	8.9		10.8	9.7	8.8	140
145				11.2	9.2	8.5	11.6	9.3	8.5	11.8	9.4	8.5	11.9	9.8	8.9	11.9	9.8	8.8		10.4	9.6	8.7	145
150				10.7	9	8.4	11.2	9.1	8.4	11.4	9.2	8.4	11.5	9.6	8.8	11.4	9.6	8.8		10	9.4	8.7	150
155				10.4	8.8	8.4	10.8	9	8.4	11	9.1	8.4	11.1	9.5	8.7	10.9	9.5	8.7		9.6	9.3	8.6	155
160				10	8.7	8.4	10.4	8.8	8.4	10.7	8.9	8.3	10.8	9.3	8.7	10.4	9.3	8.7		9.2	9.1	8.6	160
165				9.7	8.6	8.4	10.1	8.7	8.4	10.4	8.8	8.3	10.5	9.2	8.7	9.9	9.2	8.7		8.8	8.9	8.5	165
170				9.5	8.5	8.4	9.8	8.6	8.4	10.1	8.6	8.3	10.1	9	8.7	9.5	9	8.6		8.5	8.6	8.5	170
175				9.2	8.4	8.4	9.6	8.5	8.4	9.7	8.5	8.3	9.5	8.9	8.7	9.1	8.9	8.6		8.2	8.4	8.4	175
180				9	8.3		9.3	8.4	8.4	9.4	8.4	8.3	8.8	8.6	8.6	8.7	8.8	8.6		7.8	8.1	8.2	180
185				8.8	8.3		9.1	8.3	8.4	9	8.3	8.3	8.1	8.4	8.5	8.1	8.6	8.6		7.5	7.8	8.1	185
190				8.7	8.3		8.9	8.3	8.4	8.5	8.3	8.3	7.8	8.3	8.3	7.4	8.3	8.5		7.2	7.5	7.8	190
195				8.5	8.3		8.4	8.3		7.9	8.2	8.3	7.4	7.9	8.1	6.7	7.9	8.2		6.7	7.2	7.5	195
200				6.8			7.8	8.2		7.2	8.1	8.2	7	7.4	7.6	6.3	7.3	7.7		6.1	6.9	7.1	200
205							7.2	7.7		6.6	7.4	7.4	6.5	7.1	7.2	6.1	6.6	7.1		5.6	6.6	6.8	205
210							6			6	6.7		5.9	6.7	6.8	5.8	6.1	6.3		5.3	6	6.5	210
215							3.5			5.4	6		5.3	6.1	6.1	5.3	5.8	5.9	5	5	5.4	5.8	215
220										4.9	5.3		4.8	5.5		4.8	5.5	5.6		4.8	5.1	5.2	220
225										3.5			4.3	4.8		4.3	5	5		4.4	4.8	4.9	225
230													3.8	4.2		4.1	4.4			3.9	4.6	4.6	230
235													3.6			4	4.1			3.5	4.2	4.2	235
240													3.4			3.8	3.9			3.2	3.6	3.6	240
245																3.6	3.7			2.9	3.2		245
250																3.5				2.7	2.9		250
255																				2.4	2.6		255

t_270_004_16001_00_00 / t_270_004_15001_00_00

Lifting capacities

Forces de levage

TNZF

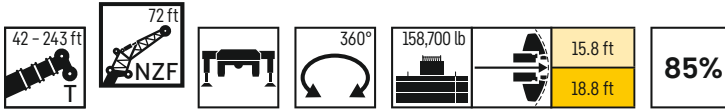

	213 ft			226 ft			230 ft			237 ft			243 ft			
	0°	22,5°	45°	0°	22,5°	45°	0°	22,5°	45°	0°	22,5°	45°	0°	22,5°	45°	
55	14															55
60	13.7			10.6			8.9			8.7						60
65	13.5			10.4			8.8			8.5			8.1			65
70	13.3			10.3			8.7			8.4			7.9			70
75	13.2			10.1			8.6			8.3			7.8			75
80	13			10			8.4			8.2			7.7			80
85	12.8			9.9			8.2			8.1			7.7			85
90	12.5	11.3		9.9			8			7.9			7.5			90
95	12.1	10.9		9.7	8.6		7.8	7.6		7.7			7.4			95
100	11.6	10.5		9.5	8.4		7.6	7.4		7.5	7.4		7.2	7.1		100
105	11.2	10.2		9.3	8.2		7.4	7.2		7.3	7.2		7	6.9		105
110	10.8	9.9	9.1	9	8	7.2	7.2	7		7.2	7		6.9	6.8		110
115	10.4	9.6	9	8.7	7.9	7.1	7	6.8	6.5	7	6.8	6.5	6.7	6.6		115
120	10.1	9.3	8.9	8.5	7.8	7	6.9	6.6	6.4	6.8	6.6	6.3	6.5	6.5	6.2	120
125	9.7	9.1	8.8	8.2	7.6	6.9	6.7	6.5	6.2	6.6	6.4	6.2	6.4	6.3	6.1	125
130	9.4	8.8	8.6	8	7.4	6.8	6.5	6.3	6.1	6.4	6.3	6	6.2	6.2	6	130
135	9.2	8.6	8.4	7.8	7.2	6.7	6.3	6.2	5.9	6.2	6.1	5.9	6	6	5.8	135
140	8.9	8.4	8.2	7.5	7.1	6.7	6.1	6	5.8	6	5.9	5.8	5.9	5.8	5.7	140
145	8.6	8.1	8	7.3	6.9	6.6	5.9	5.8	5.7	5.8	5.8	5.7	5.7	5.7	5.6	145
150	8.4	7.9	7.8	7.1	6.7	6.5	5.7	5.6	5.6	5.7	5.6	5.5	5.5	5.5	5.5	150
155	8.2	7.7	7.7	6.9	6.6	6.4	5.5	5.5	5.4	5.5	5.5	5.4	5.3	5.4	5.4	155
160	8	7.5	7.5	6.7	6.4	6.3	5.3	5.3	5.3	5.4	5.3	5.3	5.1	5.2	5.3	160
165	7.7	7.3	7.3	6.5	6.2	6.2	5.1	5.1	5.2	5.2	5.2	5.2	4.9	5.1	5.1	165
170	7.5	7.2	7.1	6.3	6.1	6.1	4.8	5	5.1	5	5	5.1	4.7	4.9	5	170
175	7.3	7	7	6.1	5.9	5.9	4.6	4.8	4.9	4.9	4.9	5	4.5	4.8	4.9	175
180	7	6.8	6.8	6	5.8	5.8	4.3	4.7	4.8	4.7	4.7	4.8	4.2	4.6	4.8	180
185	6.8	6.6	6.7	5.8	5.6	5.7	4.1	4.5	4.7	4.6	4.6	4.7	4	4.5	4.6	185
190	6.5	6.5	6.6	5.6	5.5	5.5	3.8	4.2	4.5	4.4	4.5	4.6	3.8	4.3	4.5	190
195	6.3	6.3	6.4	5.5	5.3	5.4	3.6	4	4.3	4.3	4.3	4.5	3.5	4.1	4.4	195
200	6	6.2	6.3	5.3	5.2	5.3	3.3	3.8	4.1	4.1	4.2	4.4	3.3	3.8	4.2	200
205	5.6	6	6.2	5.2	5.1	5.2	3.1	3.6	3.9	4	4.1	4.2	3.1	3.6	3.9	205
210	5.1	5.8	6	4.9	5	5.1	2.8	3.3	3.7	3.9	3.9	4.1	2.8	3.3	3.7	210
215	4.7	5.5	5.8	4.7	4.8	5	2.6	3.1	3.4	3.7	3.8	4	2.6	3.1	3.4	215
220	4.5	5	5.5	4.2	4.7	4.9	2.4	2.8	3.1	3.6	3.7	3.9	2.4	2.9	3.2	220
225	4.3	4.5	4.9	3.7	4.5	4.7		2.6	2.9	3.4	3.6	3.8		2.6	2.9	225
230	4	4.3	4.4	3.2	4.2	4.6		2.3	2.6	3.2	3.5	3.7		2.4	2.7	230
235	3.7	4.1	4.2	2.7	3.7	4.1			2.3	2.8	3.3	3.5			2.4	235
240	3.3	3.8	3.9	2.3	3.2	3.5				2.3	3.1	3.4				240
245	2.8	3.5	3.6		2.7	2.9					2.8	3.1				245
250	2.4	3	3			2.3					2.4	2.6				250
255		2.6														255

t 270_004_16001_00_000 / t 270_004_15001_00_000

Lifting capacities

Forces de levage

TNZF

	42 ft			134 ft			147 ft			160 ft			174 ft			187 ft			199 ft			
	95 ft									0°	22,5°	45°	0°	22,5°	45°	0°	22,5°	45°	0°	22,5°	45°	
	0°	22,5°	45°	0°	22,5°	45°	0°	22,5°	45°													
22	31.3																					22
24	31.2																					24
26	30.5																					26
28	29.7																					28
30	28.8																					30
32	27.9																					32
34	27.1																					34
36	26.3																					36
38	25.5			23.6																		38
40	24.7			23.2			22.1															40
45	22.5			22.1			21.3			19.8												45
50	20			21			20.5			19.1			17.3			15.1						50
55	17.8			20			19.6			18.4			16.8			14.8			12.5			55
60	16.1	12.4		19			18.8			17.7			16.2			14.4			12.3			60
65	14.6	11.4		18.1			18			17.1			15.7			14.1			12.1			65
70	13.1	10.5		17.2			17.2			16.4			15.2			13.7			11.8			70
75	12	9.7		16.4	10.5		16.5			15.8			14.7			13.3			11.6			75
80	11	9.2		15.5	10		15.8	10.7		15.2			14.2			12.9			11.3			80
85	10.2	8.6	7.5	14.6	9.6		15.2	10.2		14.6	10.1		13.8	9.8		12.6			11.1			85
90	9.4	8.2	7.2	13.8	9.3		14.6	9.8		14.1	9.8		13.3	9.6		12.2	9.2		10.8			90
95	8.8	7.7	6.9	13.1	8.9		13.9	9.5		13.6	9.4		12.9	9.3		11.9	9		10.6			95
100	8.2	7.3	6.6	12.4	8.6	6.8	13.3	9.2		13.1	9.1		12.4	9		11.5	8.8		10.3	8.4		100
105	7.8	7	6.3	11.7	8.4	6.7	12.7	8.9	7.1	12.5	8.9		12	8.7		11.2	8.5		10.1	8.2		105
110	7.3	6.7	6.1	11.2	8.1	6.5	12.1	8.6	6.9	12	8.6	6.9	11.6	8.5		10.9	8.3		9.9	8		110
115	6.9	6.4	5.9	10.6	7.8	6.4	11.6	8.4	6.8	11.6	8.4	6.7	11.2	8.3	6.7	10.5	8.1	6.6	9.7	7.8		115
120	6.6	6.1	5.8	10.1	7.6	6.2	11.1	8.1	6.6	11.1	8.1	6.6	10.8	8.1	6.6	10.3	7.9	6.5	9.5	7.6		120
125	6.2	5.9	5.8	9.7	7.4	6.1	10.6	7.9	6.5	10.6	7.9	6.5	10.4	7.9	6.5	10	7.7	6.4	9.3	7.5	6.3	125
130	5.9	5.7		9.3	7.2	6	10.1	7.7	6.4	10.2	7.7	6.4	10.1	7.7	6.4	9.7	7.5	6.3	9.1	7.3	6.2	130
135	5.7			8.9	7	5.9	9.7	7.5	6.3	9.9	7.5	6.3	9.7	7.5	6.2	9.5	7.4	6.2	8.9	7.2	6.1	135
140				8.6	6.8	5.8	9.4	7.3	6.2	9.5	7.4	6.2	9.4	7.3	6.1	9.2	7.2	6.1	8.7	7	6	140
145				8.3	6.6	5.7	9	7.1	6.1	9.2	7.2	6.1	9.1	7.1	6.1	9	7	6	8.6	6.9	5.9	145
150				8	6.5	5.7	8.7	7	6	8.9	7	6	8.9	7	6	8.7	6.9	6	8.4	6.8	5.9	150
155				7.8	6.3	5.6	8.5	6.8	5.9	8.6	6.9	5.9	8.6	6.8	5.9	8.5	6.8	5.9	8.2	6.6	5.8	155
160				7.5	6.2	5.6	8.2	6.6	5.9	8.3	6.7	5.9	8.4	6.7	5.9	8.3	6.6	5.8	7.9	6.5	5.7	160
165				7.3	6	5.5	7.9	6.5	5.8	8.1	6.6	5.8	8.1	6.6	5.8	8	6.5	5.8	7.7	6.4	5.7	165
170				7	5.9	5.5	7.7	6.4	5.8	7.9	6.4	5.8	7.9	6.4	5.8	7.8	6.4	5.7	7.5	6.3	5.7	170
175				6.8	5.8	5.5	7.5	6.2	5.8	7.6	6.3	5.7	7.7	6.3	5.7	7.7	6.3	5.7	7.3	6.2	5.6	175
180				6.6	5.7	5.5	7.3	6.1	5.7	7.4	6.2	5.7	7.5	6.2	5.7	7.5	6.2	5.6	7	6.1	5.6	180
185				6.4	5.6	5.5	7.1	6	5.7	7.2	6.1	5.7	7.3	6.1	5.7	7.3	6.1	5.6	6.8	6	5.6	185
190				6.3	5.5	5.5	6.9	5.9	5.7	7	6	5.7	7.1	6	5.6	7.1	6	5.6	6.5	5.9	5.5	190
195				6.1	5.5	5.5	6.7	5.9	5.7	6.8	5.9	5.7	6.9	5.9	5.6	6.8	5.9	5.6	6.2	5.8	5.5	195
200				6	5.4		6.5	5.8	5.7	6.7	5.8	5.7	6.7	5.8	5.6	6.4	5.8	5.6	5.9	5.8	5.5	200
205				5.8	5.4		6.3	5.7	5.7	6.5	5.7	5.7	6.2	5.8	5.6	6.2	5.8	5.6	5.7	5.7	5.5	205
210				5.7	5.4		6.2	5.7	5.7	6.3	5.7	5.7	5.9	5.7	5.6	6.2	5.7	5.6	5.2	5.6	5.5	210
215				5.6	5.4		6	5.6		6	5.6	5.7	5.6	5.6	5.6	5	5.6	5.6	4.6	5.4	5.5	215
220				5.5			5.9	5.6		5.5	5.6	5.7	5.2	5.5	5.6	4.8	5.4	5.6	4.3	5.3	5.4	220
225				3.7			5.5	5.6		4.9	5.6		4.6	5.4	5.6	4.5	4.9	5.6	4	4.9	5.3	225
230							5	5.5		4.4	5.3		4.1	5.1	5.3	4.1	4.6	4.8	3.7	4.4	5	230
235							3.5			4	4.6		3.7	4.6		3.6	4.4	4.5	3.5	3.9	4.4	235
240										3.5	4.1		3.2	4		3.1	4.1	4.2	3.2	3.7	3.9	240
245										2.9			2.8	3.5		2.9	3.6	3.2	2.8	3.4	3.6	245
250													2.5	2.9		2.8	3.1		2.4	3.2	3.3	250
255													2.3	2.4		2.6	2.8			2.8	2.9	255
260																2.5	2.6			2.4		260
265																2.3	2.5					265

t_270_004_17001_00_000 / t_270_004_18001_00_000

Lifting capacities

Forces de levage

TNZF

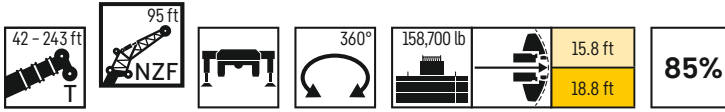

	213 ft			226 ft			230 ft			237 ft			243 ft			
	0°	22,5°	45°	0°	22,5°	45°	0°	22,5°	45°	0°	22,5°	45°	0°	22,5°	45°	
60	10															60
65	9.8			7.9			6.6									65
70	9.7			7.8			6.5			6.3			5.9			70
75	9.6			7.7			6.4			6.2			5.8			75
80	9.5			7.6			6.4			6.2			5.8			80
85	9.4			7.5			6.3			6.1			5.7			85
90	9.3			7.4			6.2			6			5.6			90
95	9.2			7.3			6.1			5.9			5.5			95
100	9.1			7.3			6			5.9			5.4			100
105	9	7.7		7.2			5.9			5.8			5.4			105
110	8.8	7.6		7.2	6		5.8			5.7			5.4			110
115	8.6	7.4		7.1	5.8		5.6	5.4		5.5	5.3		5.3			115
120	8.3	7.3		6.9	5.7		5.5	5.2		5.4	5.2		5.2	5		120
125	8.1	7.1		6.7	5.6		5.3	5		5.3	5		5	4.9		125
130	7.8	7	6	6.5	5.4		5.2	4.9		5.1	4.9		4.9	4.8		130
135	7.6	6.9	5.9	6.4	5.3	4.7	5	4.8		5	4.7		4.8	4.7		135
140	7.4	6.7	5.9	6.2	5.2	4.6	4.9	4.6	4.4	4.8	4.6	4.4	4.6	4.5		140
145	7.2	6.6	5.8	6	5.1	4.5	4.7	4.5	4.3	4.7	4.5	4.3	4.5	4.4	4.2	145
150	7	6.5	5.7	5.8	5	4.5	4.6	4.4	4.2	4.5	4.4	4.2	4.3	4.3	4.1	150
155	6.7	6.3	5.7	5.6	4.9	4.4	4.4	4.2	4.1	4.4	4.2	4.1	4.2	4.2	4	155
160	6.5	6.1	5.6	5.5	4.8	4.3	4.2	4.1	4	4.2	4.1	4	4.1	4.1	3.9	160
165	6.3	6	5.6	5.3	4.7	4.3	4	4	3.9	4.1	4	3.9	3.9	4	3.8	165
170	6.2	5.8	5.5	5.1	4.6	4.2	3.9	3.9	3.8	3.9	3.9	3.8	3.7	3.9	3.7	170
175	6	5.6	5.5	5	4.6	4.2	3.7	3.8	3.7	3.8	3.8	3.7	3.5	3.7	3.6	175
180	5.8	5.5	5.4	4.8	4.5	4.2	3.4	3.7	3.6	3.6	3.7	3.6	3.2	3.6	3.6	180
185	5.6	5.3	5.3	4.7	4.4	4.1	3.2	3.6	3.5	3.5	3.6	3.5	3	3.5	3.5	185
190	5.5	5.2	5.2	4.5	4.3	4.1	3	3.5	3.4	3.3	3.4	3.4	2.8	3.4	3.4	190
195	5.3	5.1	5.1	4.4	4.2	4.1	2.7	3.3	3.4	3.2	3.3	3.4	2.6	3.2	3.3	195
200	5.1	4.9	5	4.2	4.1	4	2.5	3.2	3.3	3.1	3.2	3.3	2.4	3	3.3	200
205	5	4.8	4.9	4.1	4	4	2.3	3	3.2	2.9	3.1	3.2	2.2	2.8	3.2	205
210	4.8	4.7	4.8	4	3.9	3.9		2.8	3.1	2.8	3	3.1		2.6	3	210
215	4.5	4.6	4.7	3.9	3.7	3.8		2.5	2.9	2.6	2.8	3		2.5	2.9	215
220	4.1	4.5	4.6	3.7	3.6	3.8		2.3	2.7	2.5	2.7	2.9		2.3	2.7	220
225	3.6	4.3	4.5	3.5	3.5	3.7			2.5	2.4	2.6	2.8			2.5	225
230	3.3	4.2	4.4	3.2	3.4	3.6			2.3	2.2	2.5	2.7			2.3	230
235	3.1	4	4.2	2.8	3.4	3.5					2.3	2.6				235
240	2.9	3.5	4	2.4	3.2	3.4					2.2	2.5				240
245	2.7	3.1	3.6		3.1	3.3						2.4				245
250	2.5	2.9	3.1		2.7	3.1						2.3				250
255		2.6	2.8		2.3	2.8										255
260		2.4	2.5			2.3										260
265			2.2													265

t 270_004_17001_00_000 / t 270_004_18001_00_000

Lifting capacities

Forces de levage

TNZF

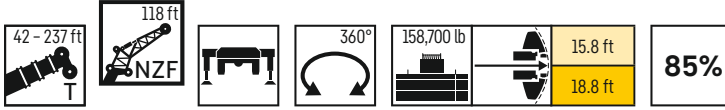

	42 ft			134 ft			147 ft			160 ft 118 ft			174 ft			187 ft			199 ft					
	0°	22,5°	45°	0°	22,5°	45°	0°	22,5°	45°	0°	22,5°	45°	0°	22,5°	45°	0°	22,5°	45°	0°	22,5°	45°			
24	22.9																					24		
26	22.9																						26	
28	22.8																						28	
30	22.4																						30	
32	21.9																						32	
34	21.4																						34	
36	21																						36	
38	20.5																						38	
40	20																						40	
45	18.8			16.8			15.9																45	
50	17.1			16.1			15.3			14.2													50	
55	15.3			15.5			14.7			13.7			12.4			10.8							55	
60	13.7			14.8			14.2			13.2			12			10.6				9.1			60	
65	12.4			14.1			13.6			12.8			11.7			10.3				9			65	
70	11.2	8.9		13.5			13			12.3			11.3			10.1				8.8			70	
75	10.3	8.3		12.9			12.5			11.8			10.9			9.8				8.7			75	
80	9.4	7.8		12.2			11.9			11.4			10.5			9.6				8.5			80	
85	8.7	7.3		11.7			11.4			10.9			10.2			9.3				8.4			85	
90	8.1	6.9		11.2	7.7		11			10.5			9.9			9.1				8.2			90	
95	7.5	6.5		10.6	7.4		10.5	7.4		10.1	7.3		9.6			8.9				8			95	
100	7.1	6.1		10.1	7.1		10.1	7.1		9.8	7.1		9.3	6.9		8.7				7.8			100	
105	6.6	5.7	5	9.7	6.9		9.7	6.9		9.5	6.8		9	6.7		8.5	6.5			7.7			105	
110	6.2	5.4	4.8	9.2	6.6		9.3	6.6		9.2	6.6		8.8	6.5		8.3	6.3			7.5			110	
115	5.8	5.1	4.6	8.8	6.4		8.9	6.4		8.8	6.4		8.5	6.3		8	6.1			7.4	5.9		115	
120	5.5	4.9	4.4	8.5	6.2	4.8	8.6	6.2		8.5	6.2		8.3	6.1		7.8	6			7.2	5.7		120	
125	5.2	4.6	4.2	8.1	6	4.7	8.2	6	4.7	8.2	6		8	5.9		7.6	5.8			7	5.6		125	
130	4.9	4.4	4	7.8	5.8	4.6	7.9	5.8	4.6	7.9	5.8	4.5	7.8	5.7		7.4	5.6			6.9	5.4		130	
135	4.6	4.2	3.9	7.4	5.6	4.5	7.6	5.6	4.5	7.6	5.6	4.4	7.5	5.6	4.4	7.2	5.5			6.7	5.3		135	
140	4.3	4	3.8	7.2	5.4	4.4	7.3	5.5	4.4	7.4	5.5	4.3	7.3	5.4	4.3	7	5.3	4.2		6.6	5.1		140	
145	4.1	3.9	3.7	6.9	5.2	4.3	7.1	5.3	4.3	7.1	5.3	4.3	7.1	5.3	4.2	6.8	5.2	4.2		6.4	5	4.1	145	
150	3.9	3.7		6.6	5.1	4.2	6.8	5.1	4.2	6.9	5.2	4.2	6.8	5.1	4.2	6.6	5	4.1		6.2	4.9	4	150	
155	3.8	3.7		6.4	4.9	4.1	6.5	5	4.1	6.6	5	4.1	6.6	5	4.1	6.5	4.9	4		6.1	4.8	3.9	155	
160				6.1	4.8	4	6.3	4.9	4	6.4	4.9	4	6.4	4.9	4	6.3	4.8	4		5.9	4.7	3.9	160	
165				5.9	4.6	3.9	6.1	4.7	4	6.2	4.8	4	6.2	4.8	3.9	6.1	4.7	3.9		5.8	4.6	3.8	165	
170				5.7	4.5	3.9	5.9	4.6	3.9	6	4.6	3.9	6	4.7	3.9	5.9	4.6	3.8		5.7	4.5	3.8	170	
175				5.5	4.4	3.8	5.7	4.5	3.8	5.8	4.5	3.8	5.8	4.5	3.8	5.8	4.5	3.8		5.5	4.4	3.7	175	
180				5.3	4.3	3.8	5.5	4.4	3.8	5.6	4.4	3.8	5.6	4.4	3.8	5.6	4.4	3.7		5.4	4.3	3.7	180	
185				5.1	4.2	3.7	5.3	4.3	3.8	5.4	4.3	3.8	5.5	4.3	3.7	5.5	4.3	3.7		5.3	4.2	3.7	185	
190				4.9	4.1	3.7	5.2	4.2	3.7	5.3	4.2	3.7	5.3	4.2	3.7	5.3	4.2	3.7		5.1	4.1	3.6	190	
195				4.8	4	3.7	5	4.1	3.7	5.1	4.1	3.7	5.2	4.1	3.7	5.2	4.1	3.6		5	4	3.6	195	
200				4.6	3.9	3.7	4.8	4	3.7	5	4	3.6	5	4.1	3.6	5	4	3.6		4.9	4	3.6	200	
205				4.5	3.8	3.7	4.7	3.9	3.7	4.8	3.9	3.6	4.9	4	3.6	4.9	4	3.6		4.7	3.9	3.5	205	
210				4.3	3.8	3.7	4.5	3.8	3.7	4.7	3.9	3.6	4.7	3.9	3.6	4.8	3.9	3.5		4.6	3.8	3.5	210	
215				4.2	3.7	3.7	4.4	3.8	3.7	4.5	3.8	3.6	4.6	3.8	3.6	4.6	3.8	3.5		4.4	3.8	3.5	215	
220				4.1	3.7		4.3	3.7	3.7	4.4	3.7	3.6	4.5	3.8	3.6	4.3	3.8	3.5		4	3.7	3.5	220	
225				4	3.6		4.2	3.7	3.7	4.3	3.7	3.6	4.3	3.7	3.6	3.9	3.7	3.5		3.6	3.7	3.5	225	
230				3.9	3.6		4.1	3.6	3.7	4.1	3.6	3.6	4.2	3.7	3.6	3.6	3.6	3.5		3.2	3.6	3.5	230	
235				3.8	3.6		3.9	3.6		4.1	3.6	3.6	3.9	3.6	3.6	3.4	3.6	3.5		2.8	3.6	3.5	235	
240				3.7	3.6		3.8	3.6		3.8	3.6	3.6	3.4	3.6	3.6	3.2	3.5	3.5		2.6	3.5	3.5	240	
245				3.6			3.8	3.6		3.4	3.5		3	3.5	3.6	2.8	3.4	3.5		2.3	3.3	3.5	245	
250							3.6	3.6		2.9	3.5		2.6	3.5	3.6	2.4	3.2	3.5			2.9	3.5	250	
255							2.8			2.5	3.3					3.2		3	3.2		2.5	3.2	255	
260												2.8				2.7			2.7	2.9		2.2	2.6	260
265																2.2						2.2	2.2	265

t_270_004_20001_00_000 / t_270_004_19001_00_000

Lifting capacities

Forces de levage

TNZF

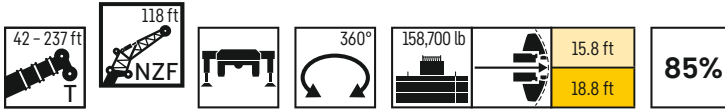

	213 ft			226 ft 118 ft			237 ft			
	0°	22,5°	45°	0°	22,5°	45°	0°	22,5°	45°	
65	7.5									65
70	7.4			5.8						70
75	7.3			5.7			4.4			75
80	7.2			5.6			4.4			80
85	7.1			5.6			4.4			85
90	7.1			5.5			4.4			90
95	7			5.4			4.3			95
100	6.9			5.4			4.3			100
105	6.8			5.3			4.2			105
110	6.7			5.3			4.1			110
115	6.5			5.2			4.1			115
120	6.4	5.4		5.2			4			120
125	6.3	5.2		5.1	4.1		3.9			125
130	6.2	5.1		5	3.9		3.8			130
135	6.1	5		4.9	3.8		3.6	3.4		135
140	5.9	4.9		4.7	3.7		3.5	3.3		140
145	5.8	4.8		4.6	3.6		3.3	3.2		145
150	5.6	4.7	3.9	4.4	3.5		3.2	3.1		150
155	5.5	4.6	3.8	4.3	3.5	2.9	3.1	2.9		155
160	5.3	4.5	3.8	4.1	3.4	2.9	2.9	2.8		160
165	5.1	4.4	3.7	4	3.3	2.8	2.8	2.7	2.6	165
170	5	4.3	3.7	3.9	3.2	2.8	2.7	2.6	2.6	170
175	4.8	4.2	3.6	3.7	3.1	2.7	2.5	2.5	2.5	175
180	4.7	4.1	3.6	3.6	3.1	2.6	2.4	2.4	2.5	180
185	4.5	4.1	3.6	3.4	3	2.6	2.2	2.3	2.4	185
190	4.4	4	3.5	3.3	2.9	2.6		2.2	2.3	190
195	4.2	3.9	3.5	3.2	2.9	2.5			2.3	195
200	4.1	3.8	3.5	3	2.8	2.5				200
205	3.9	3.7	3.5	2.9	2.7	2.5				205
210	3.8	3.6	3.5	2.8	2.7	2.5				210
215	3.6	3.5	3.4	2.7	2.6	2.4				215
220	3.4	3.4	3.4	2.5	2.5	2.4				220
225	3.2	3.3	3.3	2.4	2.4	2.4				225
230	3	3.2	3.3	2.3	2.3	2.4				230
235	2.6	3.1	3.2	2.2	2.2	2.3				235
240		3	3.1			2.3				240
245		2.9	3.1			2.3				245
250		2.7	3							250
255		2.4	2.9							255
260			2.7							260
265			2.3							265

t_270_004_20001_00_000 / t_270_004_19001_00_000

Lifting capacities

Forces de levage

TNZF

	42 ft			134 ft			147 ft			160 ft			174 ft			187 ft			199 ft			213 ft		226 ft		
	0°	22,5°	45°	0°	22,5°	45°	0°	22,5°	45°	0°	22,5°	45°	0°	22,5°	45°	0°	22,5°	45°	0°	22,5°	45°	0°	22,5°	226 ft		
28	17.4																							28		
30	17.4																								30	
32	17.4																								32	
34	17.1																								34	
36	16.8																								36	
38	16.4																								38	
40	16.1																								40	
45	15.2				12.8																				45	
50	14.4				12.3			11.6																	50	
55	13.6				11.8			11.2			10.3			9.3											55	
60	12.5				11.3			10.7			10			9.1			8.1								60	
65	11.3				10.8			10.3			9.7			8.9			8			6.9					65	
70	10.3				10.3			9.9			9.4			8.6			7.8			6.7					70	
75	9.4				9.9			9.5			9.1			8.4			7.6			6.6			5.4	3.8	75	
80	8.6				9.5			9.2			8.8			8.2			7.4			6.5			5.3	3.8	80	
85	8	6.6			9.1			8.9			8.5			7.9			7.2			6.3			5.2	3.8	85	
90	7.4	6.1			8.8			8.5			8.2			7.7			7			6.2			5.2	3.8	90	
95	6.8	5.7			8.4			8.2			7.9			7.5			6.8			6.1			5.1	3.8	95	
100	6.4	5.3			8.1			7.9			7.7			7.2			6.7			5.9			5.1	3.8	100	
105	5.9	5			7.7	5.3		7.6	5.3		7.4			7			6.5			5.8			5	3.7	105	
110	5.5	4.7			7.4	5.1		7.4	5.1		7.2	5		6.8			6.3			5.6			4.9	3.7	110	
115	5.1	4.4			7.1	4.9		7.1	4.9		6.9	4.8		6.6	4.7		6.1			5.5			4.8	3.6	115	
120	4.8	4.1			6.7	4.7		6.8	4.7		6.6	4.6		6.4	4.5		5.9	4.4		5.4			4.7	3.5	120	
125	4.5	3.9	3.4		6.4	4.5		6.5	4.5		6.4	4.5		6.1	4.4		5.8	4.2		5.2			4.6	3.4	125	
130	4.2	3.6	3.2		6.2	4.3		6.2	4.3		6.2	4.3		5.9	4.2		5.6	4.1		5.1	3.9		4.5	3.2	130	
135	3.9	3.4	3		5.9	4.1		6	4.2		5.9	4.1		5.7	4.1		5.4	4		5	3.8		4.4	3.1	135	
140	3.7	3.2	2.8		5.6	4	3	5.7	4		5.7	4		5.5	3.9		5.2	3.8		4.8	3.7		4.2	3.4	3	140
145	3.4	3	2.6		5.4	3.8	2.9	5.5	3.9	2.8	5.5	3.8		5.3	3.8		5.1	3.7		4.7	3.5		4.1	3.3	2.9	145
150	3.2	2.8	2.4		5.1	3.7	2.8	5.3	3.7	2.8	5.3	3.7	2.7	5.2	3.7		4.9	3.6		4.5	3.4		4	3.2	2.8	150
155	3	2.6	2.3		4.9	3.5	2.7	5	3.6	2.7	5.1	3.6	2.7	5	3.5	2.6	4.7	3.5		4.4	3.3		3.9	3.1	2.7	155
160	2.8	2.4			4.7	3.4	2.6	4.8	3.4	2.6	4.9	3.5	2.6	4.8	3.4	2.6	4.6	3.4	2.5	4.3	3.2		3.8	3	2.6	160
165	2.6	2.3			4.5	3.3	2.5	4.6	3.3	2.5	4.7	3.3	2.5	4.6	3.3	2.5	4.4	3.3	2.4	4.2	3.1	2.4	3.6	2.9	2.5	165
170	2.5				4.3	3.2	2.5	4.4	3.2	2.5	4.5	3.2	2.5	4.5	3.2	2.4	4.3	3.1	2.4	4	3	2.3	3.5	2.8	2.4	170
175	2.3				4.1	3.1	2.4	4.3	3.1	2.4	4.3	3.1	2.4	4.3	3.1	2.4	4.2	3	2.3	3.9	2.9	2.3	3.4	2.8	2.2	175
180					4	2.9	2.3	4.1	3	2.3	4.2	3	2.3	4.2	3	2.3	4	3	2.3	3.8	2.8	2.2	3.2	2.7		180
185					3.8	2.8	2.3	3.9	2.9	2.3	4	2.9	2.3	4	2.9	2.3	3.9	2.9	2.2	3.7	2.8		3.1	2.6		185
190					3.6	2.7	2.2	3.8	2.8	2.2	3.8	2.8	2.2	3.9	2.8	2.2	3.8	2.8		3.6	2.7		2.9	2.5		190
195					3.5	2.7		3.6	2.7		3.7	2.7		3.7	2.7		3.7	2.7		3.5	2.6		2.8	2.5		195
200					3.3	2.6		3.4	2.6		3.6	2.7		3.6	2.7		3.5	2.6		3.4	2.5		2.7	2.4		200
205					3.2	2.5		3.3	2.5		3.4	2.6		3.5	2.6		3.4	2.5		3.3	2.5		2.6	2.4		205
210					3.1	2.4		3.2	2.4		3.3	2.5		3.4	2.5		3.3	2.5		3.2	2.4		2.4	2.3		210
215					2.9	2.3		3.1	2.4		3.2	2.4		3.2	2.4		3.2	2.4		3	2.3		2.3	2.2		215
220					2.8	2.2		3	2.3		3	2.3		3.1	2.3		3.1	2.3		2.9	2.3					220
225					2.7			2.9	2.2		2.9	2.3		3	2.3		3	2.3		2.8	2.2					225
230					2.6			2.7			2.8	2.2		2.9	2.2		2.9	2.2		2.6						230
235					2.5			2.6			2.7			2.8			2.7			2.3						235
240					2.4			2.5			2.7			2.7			2.3									240
245					2.3			2.5			2.5			2.6												245
250					2.2			2.4			2.4			2.4												250
255								2.3			2.4															255
260								2.2																		260

t_270_004_22001_00_000 / t_270_004_21001_00_000

Equipment

Crane carrier

Frame	Self-manufactured, weight-optimized and torsion resistant box-type design of high-tensile structural steel.
Outriggers	4-point supporting system, hydraulically telescopic into horizontal and vertical direction. Automatic levelling of crane. Electronic inclination indicator.
Engine	6-cylinder Diesel, make Liebherr, watercooled, output 400 kW (544 h.p.), max. torque 1856 lb-ft. Exhaust emissions to (EU 2016/1628 and EPA/CARB or ECE-R.96, spark arrestor. Fuel reservoir: 172 gallons.
Transmission	ZF 12-speed gear box with automatic control system. ZF-intarder fitted directly to the gear. Two-stage transfer case with lockable transfer differential.
Axles	Low maintenance carrier axles, all 5 axles steered. Axle 2, 4 and 5 are equipped with planetary gears, all driven axles with transverse differential locks, axle 4 with longitudinal differential lock.
Suspension	All axles are mounted on hydropneumatic suspension – "Niveumatik suspension" and are lockable hydraulically.
Tyres	10 tyres. Size of tyres: 445/95 R 25 (16.00 R 25).
Steering	2-circuit system with hydraulic servo steering. Active speed depending rear axle steering, special steering programs for various driving situations.
Brakes	Service brake: all-wheel servo-air brake, all axles are equipped with disc brakes, dual circuit. Additional brakes: exhaust flap brake, Telma Eddy current brake (optional), intarder in gearbox. Hand brake: Spring-loaded, acting on all wheels of axles 2 to 5.
Driver's cab	Spacious corrosion resistant with comfort furnishings, mounted on rubber shock absorbers, safety glazing.
Electrical system	Modern data bus technique, 24 Volt DC.

Crane superstructure

Frame	Liebherr-manufactured, torsionally rigid steel construction made from high-tensile fine-grain steel. Triple-roller slewing rim.
Crane drive	Mechanical drive of the crane hydraulic from the chassis. Variable axial piston pumps with servo control and power regulation.
Control	Electric „Load Sensing“ control, simultaneous operation of 4 working motions, 2 self-centering hand control levers (joy-stick type).
Hoist gear	Axial piston fixed displacement motor, Liebherr hoist drum with integrated planetary gear and spring-loaded static brake.
Luffing gear	1 differential ram with pilot-controlled brake valve.
Slewing gear	Axial piston fixed displacement motor, planetary gear, spring-loaded static brake. Slewing gear inversible from released to locked as standard feature.
Crane cab	Large screen area, compound glass, comfort furnishing, cabin tilttable 20° to rear.
Safety devices	LICCON2 safe load indicator, test system, hoist limit switch, safety valves to prevent pipe and hose ruptures.
Telescopic boom	1 base section and 7 telescopic sections. All telescopic sections extendable individually by means of the rapid-cycle telescoping system TELEMATIK. Boom length 41 ft to 246 ft.
Counterweight	114,600 lb basic counterweight.
Electrical system	Modern data bus technique, 24 Volt DC.

Additional equipment

K	Double swing-away jib 38 ft – 66 ft Adjustment 0°, 20°, 40°
NZK	Hydraulically adjustable swing-away jib 38 ft – 66 ft Hydraulically adjustment 0° – 40°
V	Telescopic boom extension 3 x 23 ft
NZF	Fixed lattice jib 26 ft – 141 ft Hydraulic adjustment 0° – 45°
S	Powerful jib 13 ft – 128 ft, Adjustment 0°
2nd hoist gear	For two-hook operation.
Tyres	10 tyres, size 525/80 R 25 (20.5 R 25).
Drive 10 x 8	Additional drive of the 3 rd axle.
Additional counterweight	44,100 lb for a total counterweight of 158,700 lb.

Other items of equipment available on request.

Équipement

Châssis porteur

Cadre	Construction en caisse résistante à la torsion et optimisée en poids réalisée par Liebherr en acier de construction à grain fin très rigide.
Calage	Dispositif de calage horizontal et vertical en 4 points, entièrement déployable hydrauliquement. Nivellement automatique du calage. Indicateurs électroniques d'inclinaison.
Moteur	Moteur diesel, 6 cylindres, fabriqué par Liebherr, à refroidissement par eau, de 400 kW (544 ch), couple max. 1856 lb-ft. Emissions des gaz d'échappement conformes aux directives (EU) 2016/1628 et EPA/CARB ou ECE-R.96, pare-étincelles. Capacité du réservoir à carburant: 172 gallons.
Boîte de vitesse	Boîte de vitesses ZF à 12 rapports, mécanisme automatisé à commande. Ralentisseur hydrodynamique ZF directement accouplé à la boîte. Boîte de transfert à 2 étages avec blocage de différentiel.
Essieux	Essieux nécessitant peu d'entretien, les 5 essieux sont directeurs. Les essieux 2, 4 et 5 sont des essieux planétaires, tous les essieux moteurs avec différentiel transversal et l'essieu 4 avec différentiel longitudinal.
Suspension	Suspension hydropneumatique «Niveaumatik» - sur tous les essieux. Chaque essieu peut être bloqué hydrauliquement.
Pneumatiques	10 pneus. Taille: 445/95 R 25 (16.00 R 25).
Direction	2 circuits avec direction assistée hydraulique. Direction active des essieux arrière et dépendante de la vitesse, programmes de direction spéciaux pour les différents modes de déplacement.
Freins	Freins de service: servofrein à air comprimé, tous les essieux sont munis de freins à disque, à 2 circuits. Freins auxiliaire : par clapet sur échappement, frein Telma (option), ralentisseur monté sur boîte de vitesse. Frein de secours et frein à main: par cylindres à ressorts sur les essieux 2 à 5.
Cabine	Spacieuse cabine, traitement anticorrosion, équipement «grand confort», suspension par silentblochs, vitrage de sécurité.
Installation électrique	Technique moderne de transmission de données par BUS de données, courant continu 24 Volts.

Partie tournante

Cadre	Fabrication Liebherr, construction soudée indéformable, en acier à grain fin haute résistance. Couronne d'orientation à triple rangée de rouleaux.
Entraînement	Entraînement mécanique de l'hydraulique de la grue par le châssis de la grue. Pompes réglables à pistons axiaux avec servocommande et réglage de puissance.
Commande	Direction électrique "Load Sensing", 4 mouvements de travail dirigeable simultanément, deux leviers de commande à 4 positions et à autocentrage.
Mécanisme de levage	Moteur à cylindrée constante et à pistons axiaux. Treuil de marque Liebherr équipé d'un engrenage planétaire et d'un frein d'arrêt commandé par ressort.
Mécanisme de relevage	1 vérin différentiel avec clapet de frein commandé.
Dispositif de rotation	Moteur à cylindrée constante à pistons axiaux, réducteur planétaire, frein d'arrêt commandé par ressort. Commutation en série du mécanisme d'orientation: ouvert et en orientation freinée automatiquement.
Cabine de grue	Construction en tôle d'acier entièrement zinguée avec peinture par poudrage et cuisson au four, avec glaces de sécurité, appareils de commande et de contrôle, équipement confortable. Cabine inclinable vers l'arrière.
Dispositif de sécurité	Contrôleur de charge, «LICCON2», système test, limitation de la course pour le levage, soupape de sûreté contre la rupture de tubes et de tuyaux.
Flèche télescopique	Un élément de base et de 7 télescopes. Chaque partie peut être télescopée individuellement à l'aide du système de télescopage séquentiel rapide TELEMATIK. Longueur de flèche: 41 ft - 246 ft.
Contrepoids	Plaque de base 114,600 lb.
Installation électrique	Technique moderne de transmission de données. Courant continu 24 Volts.

Équipement supplémentaire

K	Double fléchette pliante 38 ft - 66 ft Positionnement à 0°, 20°, 40°
NZK	Fléchette pliante à positionnement hydraulique 38 ft - 66 ft Positionnement hydraulique à 0° - 40°
V	Rallonge flèche télescopique 3 x 23 ft
NZF	Fléchette treillis fixe 26 ft - 141 ft Positionnement hydraulique à 0° - 45°
S	Fléchette particulièrement puissante 13 ft - 128 ft, Positionnement à 0°
2ème mécanisme de levage	Pour l'utilisation du deuxième crochet.
Pneumatiques	10 pneus. Taille: 525/80 R 25 (20.5 R 25).
Entraînement 10 x 8	Essieu 3 est entraîné additionnellement.
Contrepoids additionnel	44,100 lb pour un contrepoids total de 158,700 lb.

Autres équipements supplémentaires sur demande.

Description of symbols

Explication des symboles



Max. capacity
Capacité max.



Outriggers front
Calage avant



Radius
Portée



Max. hoist height
Hauteur de levage max.



Outriggers rear
Calage arrière



Telescopic boom
Flèche télescopique



Max. radius
Portée max.



Crane superstructure
Partie tournante de la grue



Mechanically/hydraulically adjustable folding jib
Pointe pliante réglable mécaniquement / hydrauliquement



Tyres
Pneumatiques



infinitely variable
en continu



Telescopic boom extension
Rallonge flèche télescopique



Hookblock/Capacity
Moufle à crochet/Capacité de charge



Rope diameter
Diamètre



Hydraulic lattice jib
Fléchette treillis hydraulique



No. of sheaves
Poulies



Rope length
Longueur du câble



Powerful jib
Fléchette particulièrement puissante



No. of lines
Brins



Max. single line pull
Effort au brin maxi.



Weight
Poids



Hoist gear
Treuil de levage



Crane carrier
Châssis porteur



Slewing speeds
Vitesses d'orientation



Driving speed
Vitesse de translation



Boom length
Longueur de la flèche



Gradability
Aptitude à gravir les pentes



Boom position
Position de la flèche



Transmission
Boîte de vitesse



Counterweight
Contrepoids



Gear
Vitesse



Counterweight radius
Rayon de contrepoids



Onroad gear
Vitesse de route



Outriggers
Calage



Crawl speed
Marche lente



Slewing gear / Working area
Mécanisme d'orientation / Plage de travail



Max. supporting forces
Forces d'appui max.



Standard
Norme

Remarks

1. The lifting capacities do not exceed 85 % of the tipping load according to ASME B 30.5. The crane's structural steelwork is in accordance with EN 13000 and ASME B 30.5.
2. For the calculation of the load charts at least a wind speed of 30 ft/s (9 m/s, 20 mph) and regarding the load a sail area of 1 m² per ton load and a wind resistance coefficient of 1.2 on the load have been taken into account. For lifting of loads with large sail areas and/or high wind resistance coefficients the maximum wind speed as stated in the load charts has to be reduced.
3. The lifting capacities stated are valid for lifting operation only (corresponding with crane classification according to ISO 4301-1, crane group A1).
4. Lifting capacities are given in kip.
5. The weight of the hook blocks and hooks is part of the load and therefore it must be deducted from the lifting capacities.
6. Working radii are measured from the slewing centre.
7. The stated lengths of the telescopic boom are maximum values and may deviate slightly.
8. The lifting capacities given for the telescopic boom apply if the folding jib is removed.
9. Subject to modification of lifting capacities.
10. Lifting capacities above 295,400 lb / 332,900 lb only with additional pulley block/special equipment.
11. The data of this brochure serves only for general information. All information is provided without warranty. Instructions for the correct commissioning of the crane please take from the operation manual and the load chart book.
12. The pictures contain also accessories and special equipment not included in the standard scope of delivery.

Remarques

1. La capacité de charge ne doit pas dépasser 85 % de la charge de basculement conformément à ASME B 30.5. La structure métallique de la grue est conforme à EN 13000 et ASME B 30.5.
2. Une vitesse de vent de 30 ft/s (9 m/s, 20 mph) minimum, une surface de prise au vent de 1 m² par tonne ainsi qu'un coefficient de résistance au vent de la charge 1,2 sont pris en compte pour le calcul des tableaux de charge. Lorsque des charges ayant une surface de prise au vent et/ou un coefficient de résistance au vent plus élevé(e)(s) sont levées, la vitesse de vent maximale indiquée dans les tableaux de charge doit être réduite.
3. Forces de levage pour application de grue de montage (correspond à la classification de grues selon ISO 4301-1, groupe de grues A1).
4. Les charges sont indiquées en kip.
5. Le poids du crochet de levage resp. de la moufle à crochet est une partie de la charge et doit donc être déduit de la capacité de charge.
6. Les portées sont calculées à partir de l'axe de rotation.
7. Les longueurs indiquées pour la flèche télescopique sont des valeurs maximales et peuvent légèrement varier dans la réalité.
8. Les charges indiquées pour la flèche télescopique sont valables lorsque la fléchette pliante est démontée.
9. Charges données sous réserve de modification.
10. Forces de levage plus de 295,400 lb / 332,900 lb seulement avec moufle additionnel/equipement supplémentaire.
11. Les données de cette brochure sont données à titre informatif. Ces renseignements sont sans garantie. Les consignes relatives à la bonne mise en service de la grue sont disponibles dans le manuel d'utilisation et le manuel de tableaux de charge.
12. Les figures contiennent également des accessoires et des équipements spéciaux non inclus de série dans la livraison.

MyLiebherr

Our MyLiebherr portal is the easy way for you to access Liebherr's digital service world.
Take advantage of extensive basic and additional services for your mobile and crawler cranes.

Avec notre portail MyLiebherr, accédez facilement à l'univers numérique du service de Liebherr.
Bénéficiez dès maintenant d'un service global et de prestations complémentaires pour vos grues mobiles et sur chenilles.



One portal, all services

MyLiebherr



Planning

Crane Finder



Operations

Performance



Planning

Crane Planner 2.0



Operations

Documents



Maintenance

Spare Parts Catalogue



Planning

LICCON Work Planner



Training

Digital Crane Operator



Maintenance

Parts Shop

Proposition 65



WARNING: This product can expose you to chemicals, including exhaust emissions, including lead and lead compounds, which are known to the State of California to cause cancer, birth defects or other reproductive harm.
For more information see: www.P65warnings.ca.gov/diesel

Änderungen vorbehalten · Subject to modification · Sous réserve de modifications · Con riserva di modifiche · Salvo modificaciones · Возможны изменения

Liebherr-Werk Ebingen GmbH · Postfach 1361 · 89582 Ebingen, Germany
+49 73 91 5 02-0 · www.liebherr.com

MyLiebherr



Printed in Germany (5)
lwe-ta-270-02-us07-2021